

SEA&SEA

03113

UNDERWATER STROBE



YS-02

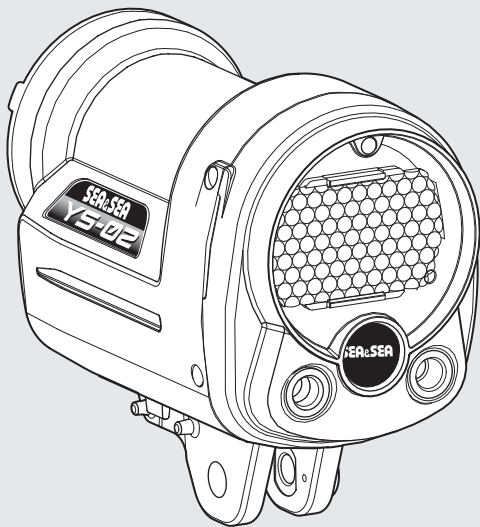

日本語

English

取扱説明書
Instruction Manual

Introduction

Thank you for purchasing SEA&SEA products.

Please read this instruction manual carefully prior to using your underwater strobe. Only with a thorough understanding of this manual's content will you be able to use the strobe correctly. After reading the manual, please be sure to keep it in a place where you can easily come back to it at any time.

Note:



Products bearing this sticker are those that have passed SEA&SEA's criteria-based inspection for pressure resistance.



This device complies with Part 15 of the FCC Rules. Operation is subject to the following two conditions: (1) this device may not cause harmful interference, (2) this device must accept any interference received, including interference that cause undesired operation.



The product conforms to WEEE standards. This symbol indicates separate collection of waste electrical and electronic equipment in the EU countries. Please do not throw the equipment into the domestic refuse. Please contact your local authorities for recycling program information.

The appearance of color evenness or weld lines on the external body of the product is normal and will not affect its performance.

Contents

Safety Precautions	E-3
Safety Precautions for Use of Battery	E-6
Accessories	E-8
Identification of Parts	E-9
Operation	E-10
Fiber-optic cable socket (for additional strobe) ...	E-11
Ready lamp	E-11
Fixing Bolt	E-11
Installing the Batteries	E-12
Connecting the Strobe	E-14
When using as a sub-strobe	E-16
Taking Photographs	E-17
Manual photography	E-17
Using the Diffuser	E-19
Maintenance and Storage	E-21
Specifications	E-22

Safety Precautions

For safe handling of the product, please read the following precautions carefully before use.

Failure to heed the precautions listed below could result in serious consequences. To prevent injury or damage to yourself and/or others, please observe the precautions as they contain highly important information related to personal and product safety.

 **DANGER** Situations that involve a high risk of severe injury or death.

 **WARNING** Situations that could result in severe injury or death.

 **CAUTION** Situations that could result in property damage or personal injury.

DANGER

- Never attempt to disassemble, repair or alter the product yourself to prevent significant electrical hazard due to the high-voltage circuitry in the product. Do not heat the product or put it into a fire, this could result in explosion or fire. Unauthorized disassembling and/or modification could result in malfunction or flooding, and avoid product warranty. Take the product to a SEA&SEA authorized service center for repair or inspection.

WARNING

- Use only batteries approved for use in this product. Do not mix old and new batteries of different types.
- Remove batteries before transport or storage, or when you are not going to use the product for an extended period of time, to prevent unexpected activation.
- Pay particular attention to opening the battery cap to avoid injury. Heat from the batteries may cause pressure buildup inside the battery compartment, and could result in cap explosion with unexpected force.
- Avoid water or foreign objects inside the product. Discontinue use and turn it off immediately should you notice flooding or leakage. Continuous use could result in complete damage to the product.
- Do not handle batteries wet hands to prevent shock hazards.
- Do not use the product in the presence of flammable gas, as this could result in explosion or fire.
- Do not fire the strobe/light with the reflector touching a person or object to prevent heat generation. Touching the reflector immediately after firing could result in burns.

- Do not fire the strobe or illuminate the light towards a driver of a vehicle to avoid causing accidents.
- Do not operate the product while driving a vehicle. Inattention could result in accidents.
- For use on land, do not operate the product at precarious foothold. It may cause falling, injury or product damage.
- Do not leave the product on a slope or an unstable surface. It may be broken after falling or injure someone below it.
- Keep out of reach of children to prevent accidental ingestion. If swallowed, seek medical advice immediately.

CAUTION

- Read the instruction manual and observe proper precautions before use of this product.
- This product has been designed and manufactured for use at a water depth within 75m / 250ft. Please note that diving to a depth in excess of 75m / 250ft may cause damage to the product or may lead to water leakage.
- Should you notice smoke or an unusual smell coming from the product, turn it off and remove the batteries immediately, taking care to avoid burns. Continued operation could result in injury. After removing the battery, take the product to a SEA&SEA authorized service center for inspection.
- Discontinue use and turn the product off immediately should you notice flooding or leakage.
- When the product is flooding, interior pressure may build up. Please be careful when opening the product as water may spurt out or the cap may open explosively and cause injuries.
- Do not open the battery cap in the vicinity of open flames.
- The product has been constructed with an airtight seal. When packing the product for airplane travel, do not seal-up the product to alleviate pressure build up due to atmospheric changes.
- Do not open the product in a wet or sandy environment. Protect the interior from moisture and debris in order to prevent malfunction or flooding.
- Keep away from strong magnetic fields. Do not use or store this product in the vicinity of equipment that generates strong electro-magnetic radiation or magnetic fields. Strong static charges or the magnetic fields could cause malfunction, or affect the product's internal circuitry.
- Before using the product in an airplane or a hospital, check if it is allowed. Electromagnetic waves emitted by the product may interfere with the measuring instruments or medical equipment.
- Do not cover or wrap the product with a cloth. This could result in deformation of the product or in fire.

Safety Precautions

- Using the strobe close to your subject's eyes could cause temporary visual impairment. Particular care should be observed if photographing infants, the strobe should be no less than one meter (3 feet) from the subject.
- Be careful when touching the product immediately after firing repeatedly or lighting for a long time. The product may get hot enough to burn you.
- Avoid strong shocks / impacts or excess stress to prevent malfunction, damage or breakdown. Make sure that the product has been securely mounted to other products in order to prevent injury, fall or missing.
- Do not carry the camera or housing by holding the accessories such as arm, cable, strobe, etc. Heavy components may fall and cause damage or injury.
- Do not rest heavy weight on the product. It might deform the outer casing, damage internal parts, make the waterproofing fail, or result in fire or electric shock.
- Rinse the product with fresh water, after underwater use. Ensure that the product is waterproofed before rinsing. Refer to [Maintenance and Storage] for details.
- Never use chemicals, cosmetics, any petroleum solvents such as paint thinner, or neutral detergent on the product. They may deform and damage the product.
- Do not leave the product in places with hot temperatures such as inside of a car or in a car trunk in summer. The heat may deform plastic parts of the product, damaging internal parts and resulting in potential fire or electric shock. If the product is sealed tight in hot conditions, heated air expanding inside the product may deform the casing and ruin the waterproofing.
- Do not store the product in wet or high humidity place, to avoid mold, rust, corrosion or malfunction.
- Do not store the product with naphthalene or camphor mothballs, or in locations such as a laboratory where chemicals are used. This environment can cause mold, rust, corrosion or malfunction.
- If you do not use the product for an extended period of time, periodic maintenance will keep internal electronic parts from deterioration. Once a month, install batteries and fire a test flash / light on. Operate all other switches as you would in normal operation. Turn the power off, then remove batteries while the Ready lamp (red) is on for the strobe.
- SEA&SEA SUNPAK Co., Ltd. assumes no liability for compensation of loss of captured images or expenses caused by loss of images, even if you are unable to shoot due to a product defect or malfunction.
- SEA&SEA SUNPAK Co., Ltd. will not be responsible for the replacement or compensation for cameras, lenses or those accessories damaged due to your invalid operation.
- Carefully observe the O-ring maintenance manual for the handling of O-rings before use.

- SEA&SEA SUNPAK Co., Ltd. assumes no liability for errors or discrepancies in this manual.
- Specifications and appearance are subject to change without notice.
- The silicon grease included in the product package is inedible.

Safety Precautions for Use of Battery

DANGER

- Never expose the battery to flame or fire, or to excessive heat.
- Never attempt to disassemble, alter or directly solder the battery. There are no user-serviceable parts. Tampering with battery may expose you to dangerous voltage, battery acid, or electrical shock.
- Never short-circuit the terminals of a battery, as it could result in battery leakage, heat generation, fire, or explosion. Avoid contact with all metal objects during transporting and storage.
- When recharging batteries such as nickel metal-hydride or lithium-ion batteries, use a charger designed specifically for them and follow the recharging instructions. Recharging in an inappropriate charger may cause battery leakage, overheating, and explosion.
- Move leaking batteries away from fire or open flames immediately. The leaked fluid and its vapor are combustible.
- If the battery leakage contacts your skin or clothing, flush the affected area repeatedly with clean water. It may irritate your skin.
Should it get into your eyes, immediately rinse them with plenty of water, avoid rubbing and seek medical advice.
- Never attempt to insert the battery upside down or backward, as it could result in battery leakage or explosion. Always confirm the direction of plus and minus before installation.
- Never connect a battery directly to a plug outlet or car cigarette lighter.

WARNING

- Keep dry. The battery is not waterproof, and may malfunction if immersed in water or exposed to high levels of humidity. Rusting of the internal mechanism can cause irreparable damage.
- Do not remove and/or damage the case of a battery. It may cause battery leakage, overheating or explosion.
- Do not charge a rechargeable battery beyond the specified charging time, it may cause battery leakage, fire hazard or explosion.

Safety Precautions for Use of Battery

- Never use batteries should you notice any changes such as leakage, discoloration or deformation. When you notice the situation as abnormal, discontinue use immediately and take the product to a SEA&SEA authorized service center for inspection.
- Keep out of reach of children to prevent accidental ingestion. If swallowed, seek medical advice immediately.
- Do not leave or use batteries in an extreme hot environment. This may cause battery leakage, overheating or battery performance deterioration.

CAUTION

- Avoid strong shocks / impacts or excess stress to batteries.
- For handling and recharging of a battery, refer to the instruction manual of the battery/dedicated charger.
- Do not use or discharge the battery at ambient temperatures below 0°C (32°F) or above 50°C (122°F).
- During recharging, the temperature should be in the vicinity from 0°C to 40°C (32°F to 104°F).
- Always recharge the rechargeable battery before use after an extended time of storage.
- Do not recharge battery in a cold environment below 0°C (32°F). Severe cold may cause battery leakage, deterioration in performance, or shortened life.
- Dirt on the battery terminals can prevent the product from functioning. Should the battery terminals become dirty, wipe them with a clean, dry cloth before use.
- Turn the equipment off after use. Remove batteries from the equipment when not in use. Store in dry area with temperatures ranging from -20°C to 30°C (-4°F to 86°F).
- Used rechargeable batteries are valuable resource. Please recycle used rechargeable batteries in accordance with local regulations.

Accessories

Before using this model, check to make sure that all accessories are present.

YS-02

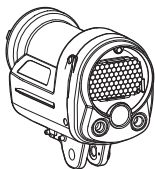

Diffuser



Diffuser Strap



Sillicon Grease



Fixing Bolt



- O-ring Maintenance Manual
- YS-02 Instruction Manual (this manual)

Identification of Parts

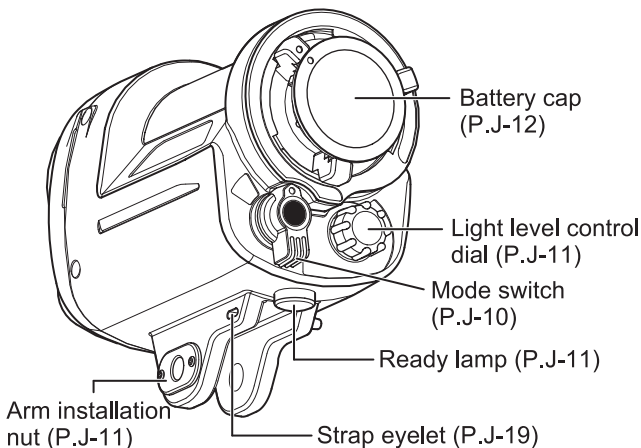
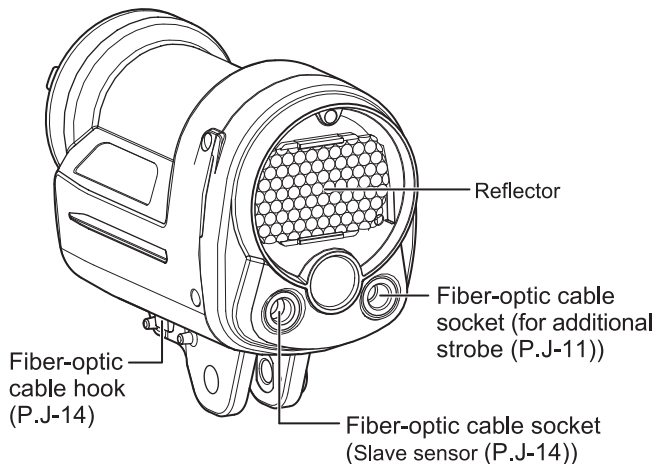

Operation

Mode Switch

OFF Turns the power off. Set the mode switch to [OFF] when you are not using the strobe.

 Set the mode switch to this position when you shoot with manual flash using a digital camera that pre-flashes.

 Set the mode switch to this position when you shoot with manual flash using a digital camera that does not pre-flashes.

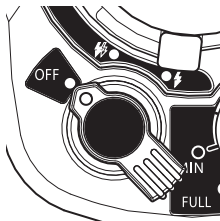

Pre-flash

With some types of digital cameras, the light amount is adjusted with the first flash and the image is taken with the second flash (main flash). The first flash for adjusting the light amount is called a pre-flash. With the normal slave function, the strobe will fire in synchronization with the pre-flash. As a result, it will recharge during the second flash (main flash) and be unable to fire.

CAUTION

- The number of times a digital camera's built-in flash will fire differs among models. Depending on the number of pre-flashes mode switch settings can differ, so check settings before shooting by conducting test flashes.
- When 30 minutes has passed from turning on the power, or last emission of the strobe, the power will turn off automatically (auto power-off). When turning on the power again, set the mode switch to [OFF] before setting the desired mode.

Light level control dial

Light amount can be adjusted in 10 increments when the mode switch is set to [⚡] or [⚡]. Marks can be used to verify 1/4 (●) or 1/2 (●) of full flash.

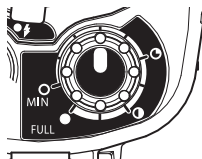

Fiber-optic cable socket (for additional strobe)

The fiber-optic cable socket (for additional strobe) is not a slave sensor. When using this strobe as a main strobe etc., another strobe can be added using a fiber-optic cable.

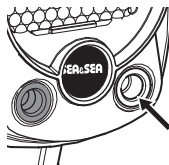

Ready lamp

Illuminates in red when the strobe is ready to fire.

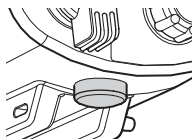

Fixing Bolt

To mount the strobe to an arm, insert the fixing bolt in the direction of the arrow.

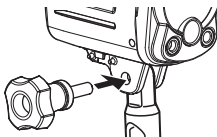

CAUTION

- Take care not to insert the fixing bolt from the wrong side, as this can result in damage to the arm installation nut.
- Do not tighten the fixing bolt up on the product unless it is being attached to an arm.
- Remove the fixing bolt from the product when storing.

Installing the Batteries

This model can be powered by the following batteries.
Use four of each type.

AA alkaline battery, AA Ni-MH battery, AA oxyride battery

- 1 **Make sure that the mode switch is in the OFF position**
- 2 **Turn ① counterclockwise to the OPEN ● position**
- 3 **Pull the battery cap straight out**

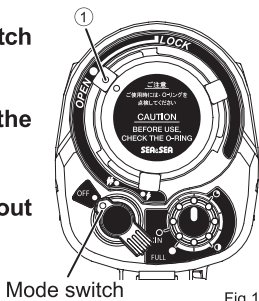

Fig.1

- 4 **Insert four batteries aligned to the + and - marks**
 - Take care to insert the batteries in the correct direction.
- 5 **Apply silicon grease to the battery cap's O-ring**
 - Check the O-ring to make sure there are no scratches or debris, and apply a light coating of the included silicon grease.

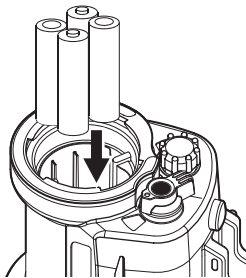

Fig.2

- 6 Align the round mark and ① on the battery cap with the OPEN ● position, insert the battery cap into the strobe

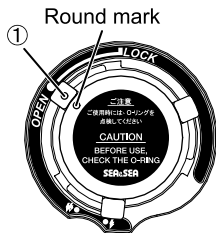

Fig.3

- 7 Turn ① clockwise to the LOCK position

- Turn until you hear the sound of it clicking into place.

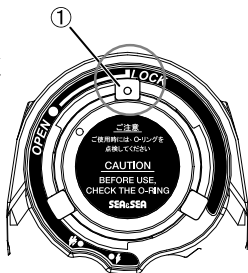

Fig.4

⚠ CAUTION

- Replace the batteries when it takes 30 seconds or more until the Ready lamp illuminates in red after firing with FULL output.
- When installing or removing batteries, thoroughly wipe water off the strobe and dry your hands. Pay particular attention not to allow water from your hair or wetsuit to drip into the battery compartment. This is in order to prevent an electrical hazard, mold, malfunction or flooding.
- Never mix old and new batteries or batteries of different types.
- Always replace all batteries with new batteries at the same time.

Connecting the Strobe

When you use this strobe, connect the strobe to the camera (housing) with a fiber-optic cable (optional). Using a built-in slave sensor, this strobe is triggered by sensing the light from a digital camera's built-in flash. If the fiber-optic cable is not used, depending on the shooting conditions the strobe may not fire.

⚠ CAUTION

- Some housings are not compatible with fiber-optic cable.

1 Insert the fiber-optic cable's connector into the fiber-optic cable socket (slave sensor) of the strobe until it stops

- When inserting the fiber-optic cable into the socket for additional strobe, the strobe will not fire correctly. Please refer to page E-11 for details.
- Refer to page E-16 when using this strobe as a sub-strobe.

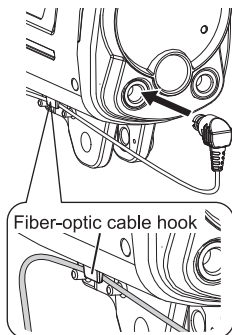

2 Secure the fiber-optic cable with the fiber-optic cable hook

3 Connect the fiber-optic cable's connector to the socket in the housing

- When the housing is not equipped with the socket, attach the optional strobe mask (A) to the flash window of the housing, and then connect the fiber-optic cable (B).

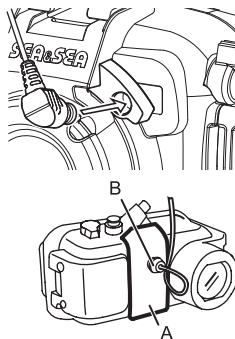

CAUTION

- When shooting, set the built-in flash of the camera to the forced-flash mode. The strobe will not fire unless the built-in flash of the camera fires. Refer to the digital camera instruction manual for setting the forced-flash mode.
- Refer to the fiber-optic cable instruction manual before use.
- When using this model together with the SEA&SEA DX-8000G/DX-1G/DX-2G set, please attach the fiber-optic cable adapter (included in the DX-8000G/DX-1G/DX-2G) to the housing, and then use a fiber-optic cable.
- Refer to the housing instruction manual before use.

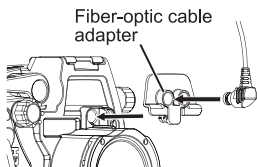

When using as a sub-strobe

This strobe can be used as a sub-strobe if it is connected through a fiber-optic cable to a main strobe that is connected to a digital camera. Please set the mode switch on the main strobe and the sub-strobe each according to the following list.

Camera	Main strobe	Sub-strobe
With pre-flash(es)	TTL <emits pre-flashes>	⚡ (Manual)
	⚡ (Manual) <does not emit pre-flashes>	⚡ (Manual)
Without pre-flash	⚡ (Manual) <does not emit pre-flashes>	⚡ (Manual)



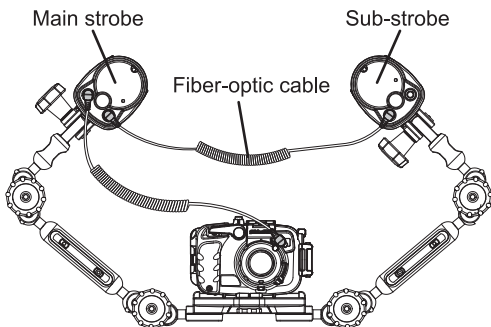

* Please refer to page E-17 for settings for a camera and the YS-02.



Taking Photographs

When shooting, set the built-in flash of the camera to the forced-flash mode. The strobe will not fire unless the built-in flash of the camera fires.

Settings chart

	Camera / Housing	Mode switch setting
		Manual
SEA&SEA	DX-1200HD DX-8000G DX-1G DX-2G *	
	RDX-450D RDX-500D RDX-D60 * MDX-D700 *	
Other	With pre-flash(es)	
	Without pre-flash	

* Set the mode switch to [] when shooting with a manual flash using a camera whose pre-flash(es) for its built-in flash is cancelled by changes to the flash control function.



(Current as of Apr 2010)

- Please refer to our website (<http://www.seaandsea.jp>) for the latest information.

Manual photography

Light amount of the strobe can be adjusted with the light level control dial.

1 Set the mode switch to [] or []

- When shooting with a digital camera that pre-flash, set to []
- When shooting with a digital camera that does not pre-flash, set to []

2 Adjust with the light level control dial

3 Take a photograph

To check the mode switch

You can check whether the settings of the mode switch are correct, by shooting the strobe with a digital camera. The number of times a digital camera's built-in flash will fire differs depending on the shooting mode. If you change the shooting mode of the camera, check the setting of the mode switch again for that mode.

- 1 **Set the camera's built-in flash to the forced-flash mode, and mount the camera to the housing. Then, connect the housing and this product together with a fiber-optic cable**

- Release the red-eye-reduction function.

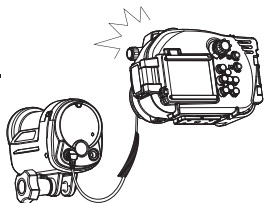

- 2 **Set the mode switch to [⚡] and the light level control dial to [FULL], point the digital camera at the front of the strobe and shoot an image**

- The built-in flash of the camera must flash.

- 3 **Check the image captured by the camera**

- If you see a white flash in the strobe or an image that is completely white, then the strobe has fired and the setting is correct.
- If the image shows a dark reflection from the strobe, that means that it is not synchronized and the strobe didn't fire. Change the mode switch to [⚡], try taking another picture, and then check the new picture.

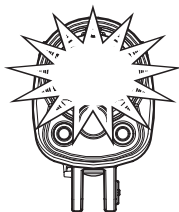

Using the Diffuser

Use of the diffuser is highly recommended for shooting short camera-to-subject distances.

Attaching the diffuser

- 1 **Attach the included diffuser strap to the strap eyelets on the diffuser and the strobe**

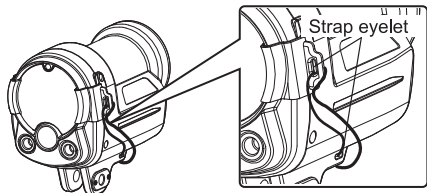

- 2 **Align the notches on the top and bottom of the diffuser with the protrusions on the reflector**
- 3 **Firmly set the tabs on the diffuser into the grooves on the right and left side of the body**

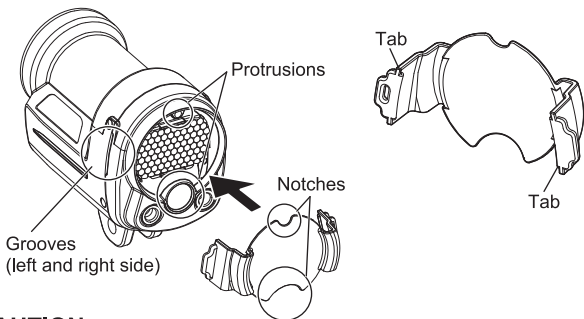

! CAUTION

- Always make sure that the diffuser is properly attached before use. If not properly attached, it may fall off, get lost or become damaged.

Detaching the diffuser

Pinch in and pull up on the tabs (A) simultaneously to remove the tabs from the side grooves.

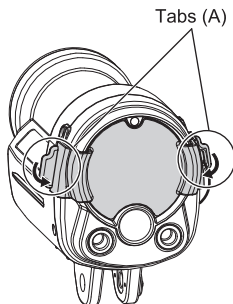

⚠ CAUTION

- Do not try to forcibly remove the diffuser with the tab on only one side as doing so may cause breakage.

Maintenance and Storage

CAUTION

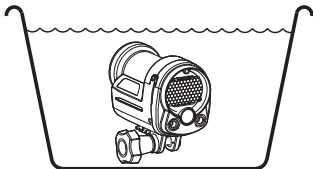

- Never use chemicals, cosmetics, any petroleum solvents such as paint thinner, or neutral detergent on the product. They may deform and damage the product.
- After each use in salt water, make sure the battery and connector caps are attached, then in a watertight condition soak it sufficiently in fresh water.
- Insufficient soaking causes damage by salt to the product.



Salty residue may be left on the product where it will crystallize as it evaporates. Crystallized salt is hard to dissolve and difficult to be removed once formed, and it will result in water leakage.

- After rinsing, dry the product well with a soft dry cloth, then let the product dry in the shade, out of direct sunlight.
- Do not dry the product by heating (using a hair dryer, for example). Heating can deform and damage the product.
- If you will not use the product for an extended period of time, store it away from high temperatures, high humidity, direct sunlight, or extreme cold.
- Do not store the product with naphthalene or camphor mothballs, or in locations such as a laboratory where chemicals are used. This environment can cause mold, rust, corrosion or malfunction.
- Always remove batteries from the product after use.
- After using the product, maintain the O-rings before storing. Examine the O-rings before and after each dive. We recommend early exchange of the O-rings, at least once a year.
- Every two years we recommend a complete overhaul of O-rings regardless of the frequency in use, for the best performance of the product.
- If you do not use the product for an extended period of time, periodic maintenance will keep internal electronic parts from deterioration. Once a month, install batteries and fire a test flash. While the Ready lamp is red (strobe is ready to fire), set the mode switch to [OFF], then remove the batteries. In addition, operate all other switches as you would in normal operation.

Specifications

Controls and functions	Mode switch (OFF /  / ) Light level control dial (10 increments)
Indicator	Ready lamp (Illuminates in red when the strobe is ready to fire.)
Guide number	20 (at full flash) * ISO100/m * Depending on the camera models.
Beam angle	100° × 100° 105° × 105° (with Diffuser)
Color temperature	5600° K (at full flash) 5250° K (with Diffuser)
Battery life	Alkaline : Approx. 230 flashes Ni-MH (2700mAh) : Approx.330 flashes
Recycle time	Alkaline : Approx. 2.5 sec Ni-MH (2700mAh) : Approx.1.9 sec
Battery requirements	4 × AA Alkaline, 4 × AA Ni-MH (2700mAh), 4 × AA Oxyride
Operating temperature	0°C-40°C / 32° F-104° F
Construction	ABS resin, Polycarbonate resin
Depth rating	75m (250ft)
Dimensions (WxHxD)	68 × 108 × 129mm / 2.7 × 4.3 × 5.2inch
Weight	450g / 15.8oz (excl. batteries)
Weight underwater	-10g / -0.35oz (incl. batteries)

* The specifications and appearance are subject to change without notice.

* The performance values above may change depending on variables such as frequency of use, battery consumption, recharge level, and so on.

* The above specifications are based on normal room temperature (25°C / 77° F).

Memo

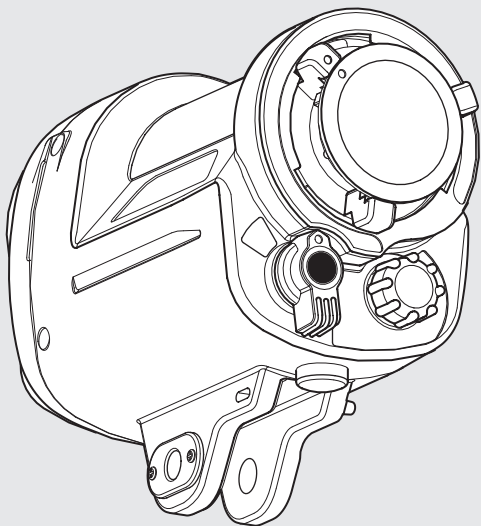

SEA&SEA

シーアンドシー・サンパック株式会社

〒332-0016 埼玉県川口市幸町3-2-20
TEL048-256-2251

カスタマーサービスセンター

TEL048-255-8512
<http://www.seaandsea.co.jp>

SEA&SEA SUNPAK Co., Ltd.

3-2-20, Saiwai-cho, Kawaguchi-shi,
Saitama, Japan 332-0016
TEL. +81-48-256-2251

World Customer Service Center

TEL. +81-48-255-8512
<http://www.seaandsea.jp>

0919-Z-01B
(2010年4月現在 / Current as of Apr.2010)