

SEA&SEA

03129

UNDERWATER STROBE



YS-D3 DUO

Rev.1.06

English

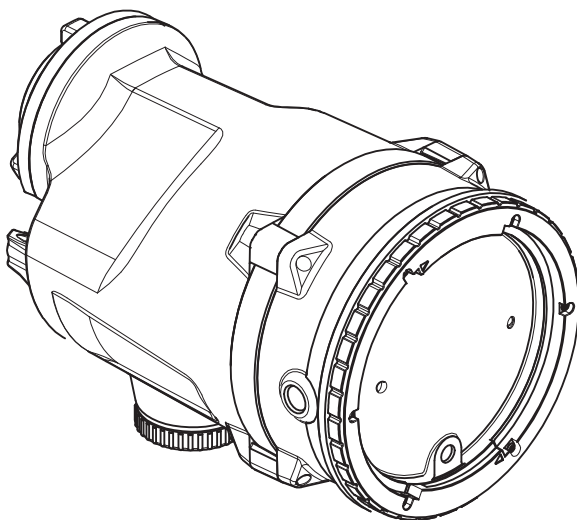

取扱説明書
Instruction Manual

Introduction

Thank you for purchasing SEA&SEA products. Please read this instruction manual carefully prior to using your underwater strobe. Only with a thorough understanding of this manual's content will you be able to use the strobe correctly. After reading the manual, please be sure to keep it in a place where you can easily come back to it at any time.

Note:

This products have passed SEA&SEA's criteria-based inspection for pressure resistance.



This device complies with Part 15 of the FCC Rules. Operation is subject to the following two conditions: (1) this device may not cause harmful interference, (2) this device must accept any interference received, including interference that cause undesired operation.



The product conforms to WEEE standards. This symbol indicates separate collection of waste electrical and electronic equipment in the EU countries. Please do not throw the equipment into the domestic refuse. Please contact your local authorities for recycling program information.

The appearance of color evenness or weld lines on the external body of the product is normal and will not affect its performance.

This Class B digital apparatus complies with Canadian ICES-003. CAN ICES-3(B)/NMB-3(B)

Contents

Safety Precautions	E-03
Safety Precautions for Use of Battery	E-06
Precautions on Handling the O-rings	E-08
Check the bundle	E-10
Name of each part	E-11
Switch operation	E-12
READY/TTL lamp and buzzer	E-14
Strobe YS Base/Strobe Ball Base	E-15
Preparation for Filming	E-17
Put the batteries in	E-17
Set up the strobe	E-19
Connect with fiber optic cable	E-20
Connect with a sync cord	E-22
Quick Setup Guide	E-24
Take a picture	E-25
When connected via fiber-optic cable	E-25
When connected with a synchro cord	E-28
Use a diffuser	E-29
Customize mode	E-31
[DS-TTL]Pre-flash cancel setting	E-31
[DS-TTL]Optical input setting	E-32
[RC mode]Channel number setting	E-34
[RC mode]Group Settings	E-35
[System]Buzzer/panel light setting	E-36
[System]Auto power off/Sleep setting	E-37
[System]Reset settings (restore factory defaults)	E-39
Care and Storage Precautions	E-40
Troubleshooting	E-41
Specification	E-43
List of settings by camera	E-44
Warning and Abnormality Indication	E-47

Safety Precautions

SEA&SEA strobes have been designed for in-water use only. Limit the strobes use out of water to test firing only.

For safe handling of the product, please read the following precautions carefully before use.

Failure to heed the precautions listed below could result in serious consequences. To prevent injury or damage to yourself and/or others, please observe the precautions as they contain highly important information related to personal and product safety.

 **DANGER** Situations that involve a high risk of severe injury or death.

 **WARNING** Situations that could result in severe injury or death.

 **CAUTION** Situations that could result in property damage or personal injury.

DANGER

- Never attempt to disassemble, repair or alter the product yourself to prevent significant electrical hazard due to the high-voltage circuitry in the product. Do not heat the product or put it into a fire, this could result in explosion or fire. Unauthorized disassembling and/or modification could result in malfunction or flooding, and void product warranty. Take the product to a SEA&SEA authorized service center for repair or inspection.

WARNING

- Use only batteries approved for use in this product. Do not mix old and new batteries of different types.
- Remove batteries before transport or storage, or when you are not going to use the product for an extended period of time, to prevent unexpected activation.
- Pay particular attention to opening the battery cap to avoid injury. Heat from the batteries may cause pressure buildup inside the battery compartment, and could result in cap explosion with unexpected force.
- Prevent water or foreign objects from entering the product. Discontinue use and turn it off immediately should you notice flooding or leakage. Continuous use could result in complete damage to the product.
- Do not handle batteries with wet hands to prevent shock hazards.
- Do not use the product in the presence of flammable gas, as this could result in explosion or fire.
- Do not fire the strobe/light with the reflector facing a desk or floor to prevent a fire from occurring. Touching the reflector immediately after firing could result in burns.

- Do not fire the strobe light towards a driver of a vehicle to avoid causing accidents.
- Do not operate the product while driving a vehicle. Inattention could result in accidents.
- For use on land, do not operate the product at precarious foothold. It may cause falling, injury or product damage.
- Do not leave the product on a slope or an unstable surface. It may be broken after falling or injure someone below it.
- Keep out of reach of children to prevent accidental ingestion. If swallowed, seek medical advice immediately.

CAUTION

- Read the instruction manual and observe proper precautions before use of this product.
- This product has been designed and manufactured for use at a water depth within 100m / 330ft. Please note that diving to a depth in excess of 100m / 330ft may cause damage to the product or may lead to water leakage.
- Should you notice smoke or unusual smell coming from the product, turn it off and remove the batteries immediately, taking care to avoid burns. Continued operation could result in injury. After removing the battery, take the product to a SEA&SEA authorized service center for inspection.
- Discontinue use and turn the product off immediately should you notice flooding or leakage.
- When the product is flooded, interior pressure may build up. Please be careful the cap may open explosively and cause injuries.
- Do not open the battery cap in the vicinity of open flames.
- The product has been constructed with an airtight seal. When packing the product for airplane travel, Please be transported Remove the battery cap.
- Do not open the product in a wet or sandy environment. Protect the interior from moisture and debris in order to prevent malfunction or flooding.
- Keep away from strong magnetic fields. Do not use or store this product in the vicinity of equipment that generates strong electro-magnetic radiation or magnetic fields. Strong static charges or the magnetic fields could cause malfunction, or affect the product's internal circuitry.
- Before using the product in an airplane or a hospital, check if it is allowed. Electromagnetic waves emitted by the product may interfere with the measuring instruments or medical equipment.
- Do not cover or wrap the product with a cloth when firing the strobe. This could result in deformation of the product or in fire.
- Using the strobe close to your subject's eyes could cause temporary visual impairment. Particular care should be observed if photographing infants, the strobe should be no less than one meter (3 feet) from the subject.

- Be careful when touching the product immediately after firing repeatedly or lighting for a long time. The product may get hot enough to burn you.
- Avoid strong shocks / impacts or excess stress to prevent malfunction, damage or breakdown. Make sure that the product has been securely mounted to other products in order to prevent injury, fall or missing.
- Do not carry the camera or housing by holding the accessories such as arm, cable, strobe, etc. Heavy components may fall and cause damage or injury.
- Do not rest heavy weight on the product. It might deform the outer casing, damage internal parts, make the waterproofing fail, or result in fire or electric shock.
- Rinse the product with fresh water, after underwater use. Ensure that the product is watertight before rinsing. Refer to [Maintenance and Storage] for details.
- Make sure that the connectors have been secured with the connector caps before rinsing the product with fresh water, after removal from other products.
- Never use chemicals, cosmetics, any petroleum solvents such as paint thinner, or neutral detergent on the product. They may deform and damage the product.
- Do not leave the product in places with hot temperatures such as inside of a car or in a car trunk in summer. The heat may deform plastic parts of the product, damaging internal parts and resulting in potential fire or electric shock. If the product is sealed tight in hot conditions, heated air expanding inside the product may deform the casing and ruin the watertightness.
- Do not store the product in wet or high humidity place, to avoid mold, rust, corrosion or malfunction.
- Do not store the product with naphthalene or camphor mothballs, or in locations such as a laboratory where chemicals are used. This environment can cause mold, rust, corrosion or malfunction.
- If you do not use the product for an extended period of time, periodic maintenance will keep internal electronic parts from deterioration. Once a month, install batteries and fire a test flash / light on. Operate all other switches as you would in normal operation. Turn the power off, then remove batteries while the READY/TTL lamp is on for the strobe.
- SEA&SEA SUNPAK Co., Ltd. assumes no liability for compensation of loss of captured images or expenses caused by loss of images, even if you are unable to shoot due to a product defect or malfunction.
- SEA&SEA SUNPAK Co., Ltd. will not be responsible for the replacement or compensation for cameras, lenses or those accessories damaged due to your invalid operation.
- Carefully observe the O-ring maintenance manual for the handling of O-rings before use.
- SEA&SEA SUNPAK Co., Ltd. assumes no liability for errors or discrepancies in this manual.
- Specifications and appearance are subject to change without notice.
- The silicon grease included in the product package is inedible.

Safety Precautions for Use of Battery

DANGER

- Never expose the battery to flame or fire, or to excessive heat.
- Never attempt to disassemble, alter or directly solder the battery. There are no user-serviceable parts. Tampering with battery may expose you to dangerous voltage, battery acid, or electrical shock.
- Never short-circuit the terminals of a battery, as it could result in battery leakage, heat generation, fire, or explosion. Avoid contact with all metal objects during transporting and storage.
- When recharging batteries such as nickel metal-hydride, use a charger designed specifically for them and follow the recharging instructions. Recharging with an inappropriate charger may cause battery leakage, overheating, and explosion.
- Move leaking batteries away from fire or open flames immediately. The leaked fluid and its vapor are combustible.
- If the battery leakage contacts your skin or clothing, flush the affected area repeatedly with clean water. It may irritate your skin. Should it get into your eyes, immediately rinse them with plenty of water, avoid rubbing and seek medical advice.
- Battery has a specific polarity. Never force the battery into the charger or the strobe. Always check the + and - polarity before installation. Incorrect orientation may cause permanent battery damage.
- Never connect a battery directly to a plug outlet or car cigarette lighter.

WARNING

- Keep dry. The battery is not waterproof, and may malfunction if immersed in water or exposed to high levels of humidity. Rusting of the internal mechanism can cause irreparable damage.
- Do not remove and/or damage the case of a battery. It may cause battery leakage, overheating or explosion.
- Do not charge a rechargeable battery beyond the specified charging time, it may cause battery leakage, fire hazard or explosion.
- Never use batteries should you notice any changes such as leakage, discoloration or deformation. When you notice the situation as abnormal, discontinue use immediately and take the product to a SEA&SEA authorized service center for inspection.
- Keep out of reach of children to prevent accidental ingestion. If swallowed, seek medical advice immediately.
- Do not leave or use batteries in an extreme hot environment. This may cause battery leakage, overheating or battery performance deterioration.
- Do not use non-recommended batteries (such as lithium primary batteries). Use of non-recommended batteries may cause battery leakage and overheating and may cause the strobe to rupture, which could result in personal injury.

 **CAUTION**

- Avoid strong shocks / impacts or excess stress to batteries.
- For handling and recharging of a battery, refer to the instruction manual of the battery/dedicated charger.
- Always recharge the rechargeable battery before use after an extended time of storage.
- Dirt on the battery terminals can prevent the product from functioning. Should the battery terminals become dirty, wipe them with a clean, dry cloth before use.
- Used rechargeable batteries are valuable resource. Please recycle used rechargeable batteries in accordance with local regulations.

Precautions on Handling the O-ring

This product is kept watertight by the O-ring. To keep the O-ring functioning properly, please observe the following. Improper handling of the O-ring could cause flooding.

CAUTION

- SEA&SEA products use blue O-rings. These O-rings are impregnated with silicone oil through a special process. The lubricating effect of the O-ring lasts as long as the silicone oil is gradually seeping out from within.
- For the maintenance of these blue O-rings, make sure to use genuine SEA&SEA silicone grease (O-ring grease for use with the blue O-rings that comes in tubes with blue lettering and blue caps). If you use silicone grease from other companies or SEA&SEA's own silicone grease that comes in tubes with black lettering and black caps, the grease you apply will be sucked into the blue O-rings due to their special characteristics, which will result in insufficient grease. If this happens even once, the O-ring will not revert to its normal state and must be replaced.
- If the grease is insufficient, the O-ring will not slide, and it will become harder to open and close the waterproof parts. Because of this, it could become impossible to open or close the housing or it could cause flooding, so please refrain from using the housing with insufficient grease.

Are there any scratches or cracks in the O-ring?

Check the O-ring to make sure there are no scratches or cracks. If there are, replace the O-ring with a new one immediately. When handling the O-ring, do not use pointed metal objects, which could damage the O-ring.

Be careful about dust, sand, and hair

Check the O-ring to make sure that there is no dust, sand, or hair on the O-ring, in the O-ring's grooves, or on the O-ring's contact surfaces. If any of these things are attached, remove them completely. If used as is, these things could cause flooding.

Coat with silicone grease

Silicone grease protects the O-ring from chafing. After checking the O-ring to make sure that there are no scratches, dust, or debris, apply a light coating of silicone grease to the entire O-ring with your finger. Applying too much grease will make it easier for dust and debris to adhere to the O-ring, and could cause flooding.

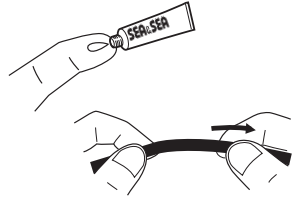

Do not twist the O-ring

When fitting the O-ring into the O-ring groove, insert it straight into the groove; do not bend or twist it.

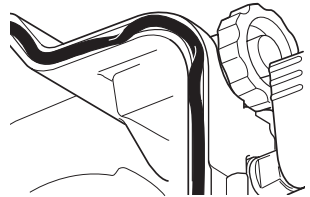

Remove the O-ring for inspection before each use

In principle, the O-ring should be removed before each use so that the O-ring, O-ring groove, and O-ring contact surfaces can be checked. This is because you cannot find any sand or debris that may have gotten into the O-ring groove if the O-ring is not removed. For routine maintenance prior to each use, it is advisable to make sure to remove the O-ring.

Be careful about how you store O-rings

When storing spare O-rings or O-rings that you have removed from the housing, keep them in a cool place out of direct sunlight. Also, when storing O-rings, do not place heavy objects on them or twist them.

O-rings last for one year

Although it depends on how well they are maintained, how often they are used, and how they are stored, O-rings generally last for one year. It is advisable to inspect them before use, and replace them early.

Check the bundle

Before using this product, please make sure that all included items are included.

YS-D3 DUO

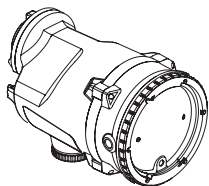

Diffuser

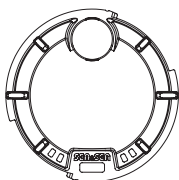

Strobe ball base

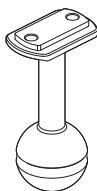

Silicon grease

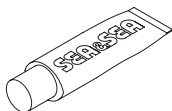

Mounting screws

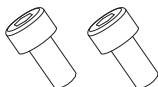

Hex wrench



**Rubber Cap for
Fiber Optic Socket**



●Strap for diffuser

Name of each part

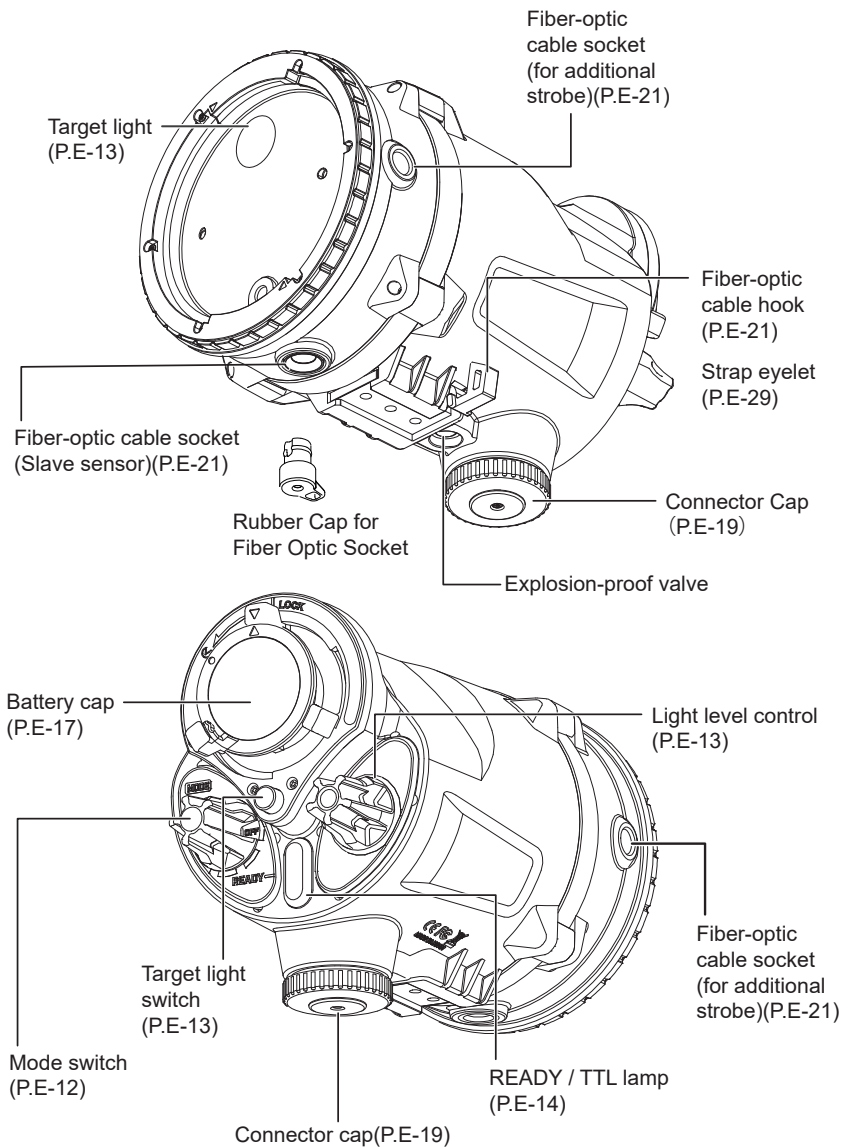

Switch operation

⚠ Caution Do not turn on the power with the light sensor exposed

Always attach the "Rubber Cap for Fiber Optic Socket" to the fiber optic socket except when attaching the fiber optic cable. If the power is turned on while the optical sensor is exposed, the optical sensor may react to external light and unexpected light emission may occur.

Mode switch

OFF Turn off the power. Turn [OFF] when not in use.

TTL Set for TTL dimming.

- DS-TTL mode is selected.

⇒ "DS-TTL mode shooting" (P.E-25)

RC Set when using the wireless RC system of the OM SYSTEM camera.

M [⚡] Set when setting to Manual 1.

- Set the digital camera with pre-flash function.

M [⚡] Set when setting to Manual 2.

- Set the digital camera without pre-flash function.

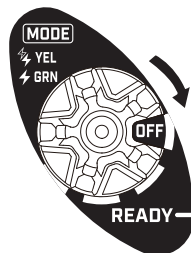

*Press and hold the target light button to switch between Manual 1 and Manual 2.

What is pre-luminescence?

Some digital cameras use a pre-flash to adjust the light before shooting (main flash). This pre-lighting is called pre-lighting.

Each mode and character emission color

The letters on the mode switch and light intensity control dial emit light in a predetermined emission color for each mode. The following table shows the luminescence colors in each mode.

Mode	Optical fiber	Synchro code
⚡ Manual 1	Orange	Green
⚡ Manual 2	Green	
DS-TTL	Blue	-
RC	Red	-
TTL	-	Light blue
Customize	White Slow Flashing/Blue Slow Flashing/Red Slow Flashing	

Various settings can be made in the customize mode. (P.E-31)

⚠ Caution

- The flash pattern of the built-in flash differs depending on the model of the digital camera. Since it is necessary to set a customized mode depending on the flash pattern, please check the setting by firing a test flash before shooting.

➡ “Check mode switch” (P.E-26)

- The power will automatically turn off (auto power off) after 60 minutes of inactivity since the power was turned on or since the last light was emitted. When turning on the power again, set the mode switch to [OFF] once and then set the desired mode.
- This strobe remembers the state in which it was turned off, so if the power is turned off in Manual 2 mode, the strobe will start up in Manual 2 mode the next time the power is turned on.

Light Quantity Adjustment Dial

When the mode is set to [⚡] or [⚡], light intensity can be adjusted in 11 steps (GN: 1 / 1.4 / 2 / 2.8 / 4 / 5.6 / 8 / 11 / 16 / 22 / 33). The light intensity setting can be checked using the pointer.

When set to [TTL] or [RC] and connected via fiber-optic cable, EV compensation from +2.0EV to -2.0EV is possible.

(EV : -2.0 / -1.5 / -1.0 / -0.7 / -0.3 / N(+/-0) / +0.3 / +0.7 / +1.0 / +1.5 / +2.0)



Target Light Button

Press the button to turn the target light on at high intensity. Press the button again to turn on the target light at a low intensity, and again to turn it off.

If the strobe fires while the target light is on, the target light will turn off and turn on again after 0.5 seconds.

In manual mode, holding this button down for 3 seconds alternates between manual 1 and manual 2 modes.

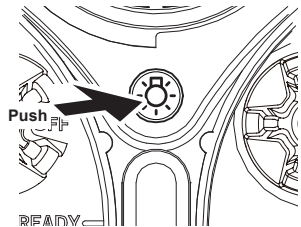

⚠ Caution

- The target light will remain on until the button is pressed to turn the light off, the mode switch is set to [OFF], or the power is turned off with auto power off.
- The brightness of the target light may become unstable depending on the amount of remaining battery power, but this is not a malfunction.

READY/TTL lamp and buzzer

Strobe status is indicated by a lamp display and an audible buzzer.

*The buzzer can be set to mute in the customize mode.(P.E-36)

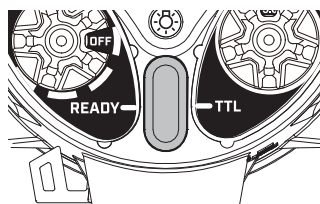

State	Lamp Indication	Buzzer operation
Charging	Green Rapid flashing	
Charging Complete	Green light	Rings for 0.5 sec.
Charge Complete (Battery Level row)	Yellow light	Rings for 0.5 sec.
Battery Level Warning	Yellow light	
No battery power left	Flashing yellow (for 10 seconds)	
During luminous processing	Turning off the light	
Luminous success	Blue light (for 1 sec.)	
Luminous failure	Red light (for 1 sec.)	
During luminescence limitation (temperature limitation)	Yellow Slow flashing	
Light emission restricted (light input restricted)	Yellow Slow flashing	
Emission Control Release	Green light	Rings for 2 sec.
Abnormality (during power-on/operation)	Flashing red (for 10 seconds)	Rings for 10 sec. at 1 sec. intervals
In sleep mode	Light blue slow flashing	
Auto power off	Light blue light (for 2 seconds)	Rings for 2 sec.
Customize mode setting in progress	White light	
Customized mode setting completed	Success: Blue light (1 sec.)	Rings for 2 sec. (success only)
	Failure: Red light (for 1 sec.)	Rings for 0.5 sec.
	Same setting: Light blue (for 0.7 sec.)	Rings for 0.5 sec.
Reset setting completed	Light blue light (for 2 sec.)	

Strobe Ball Base/Strobe YS Base

A strobe ball base is included with this product. By replacing it with the Strobe YS Base (sold separately), you can choose how to attach the strobe to the housing depending on the shooting situation.

Strobe ball base

- 1 Set the strobe ball base on the main body and lightly tighten the two screws (included) by turning them clockwise.
- 2 Tighten and secure firmly using an M4 hex wrench.
 - Use the hexagonal wrench in the short hand direction (shown at right).
 - When installing, do not screw in with more force than necessary.

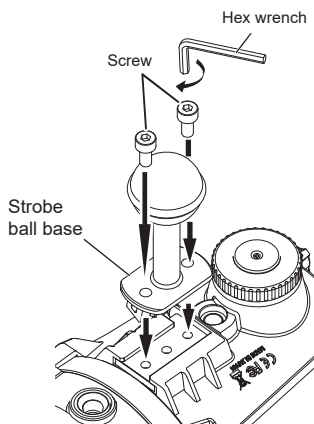

Strobe YS base (sold separately)

- 1 Use the included 2 mounting screws and hexagonal wrench to install.

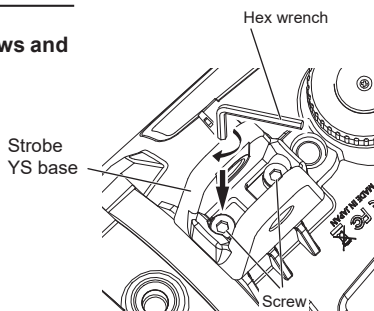

Fixing bolt/Strobe YS Base (sold separately)

When attaching this product to an arm, etc., insert the fixing bolt into the strobe YS base from the direction where the nut is not located and fix it in place.

<< Correct >>

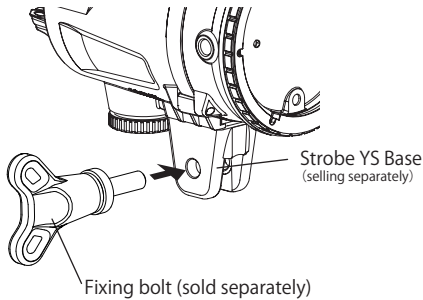

<< Wrong >>

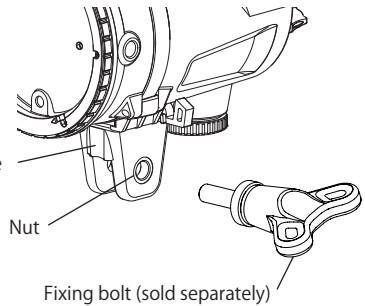

Installation from the reverse direction

By changing the mounting direction of the strobe YS base, the fixing bolt can be attached from either the left or right side.

- See "Strobe Ball Base/Strobe YS Base (P.E-15)" for details on how to install the Strobe YS Base.

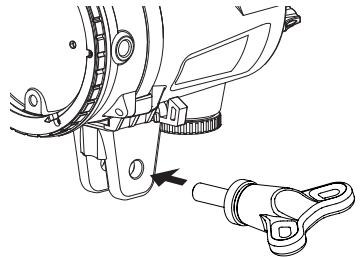

⚠ Caution

- Be careful not to install the fixing bolt by inserting it from the direction where the nut is located, as it may damage the strobe YS base or other components.
- Do not strongly tighten the fixing bolt to the product while the arm or other parts are removed.
- Remove the fixing bolt when storing the product. The strobe YS base may be deformed, making it difficult to attach the strobe to the arm.

Preparation for Shooting

O-ring maintenance

This product maintains its waterproof performance with O-rings; to take full advantage of the O-rings' functions, be sure to maintain the O-rings before setting up the product.

- O-rings must be removed for maintenance.

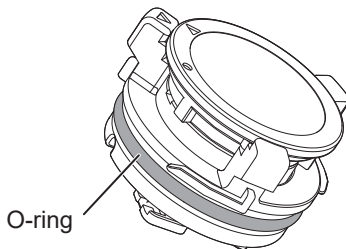

⚠ Caution

- After maintenance, install the O-ring securely in the designated O-ring groove.

Put the batteries in

To prevent water drops from falling into the battery compartment, please turn the unit on its side and open the battery cap.

The following batteries can be used in this product. Four of each are required.

AA alkaline batteries / AA nickel-hydrogen batteries

1 Make sure the mode switch is OFF.

2 Turn the ▽ mark counterclockwise to the OPEN (☺) position.

3 Pull the battery cap straight off.

- Turn the main unit on its side and open the battery cap.

4 + - Align the + and - marks and insert the battery/batteries.

- Be careful not to misorient the battery/batteries.

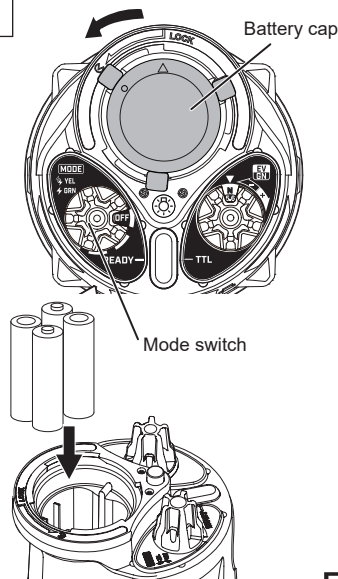

- 5 Check that the ○ and ▼ marks on the battery cap are aligned.

- Make sure there are no scratches or debris on the O-ring.

- 6 Align the battery cap with the OPEN (⊗) position and push it into the main unit.

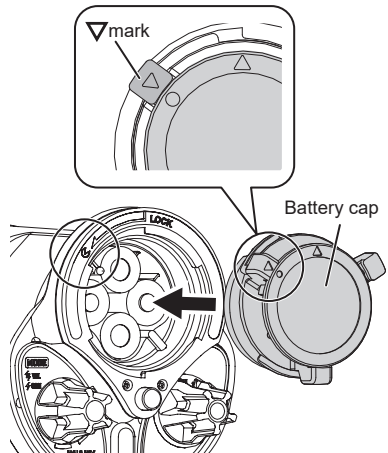

- 7 Turn the ▼ mark clockwise to the LOCK position.

- Turn it securely until it clicks into place.

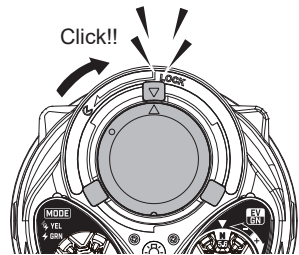

⚠ Caution

- If the lamp is lit yellow, the battery is low. Replace the battery with a charged battery or a new battery.
- When installing or replacing the battery, wipe off all moisture and use dry hands. Be especially careful of water droplets from hair and wetsuits. Doing so may cause electric shock, product mold, malfunction, or flooding.
- Please be sure to use the same type of batteries.
- When replacing batteries, replace all four batteries at the same time.

Set up the strobe.

The cords to be connected to this product and various settings differ depending on the type of camera/housing to be used.

This section describes the connection method for each connection cord. For information on how to take pictures by connection cord, see "Let's take pictures" (P.E-25).

Strobe Set Quick Reference Table

Manual Shooting

Camera side	Mode switch	Connection cord
Built-in camera flash	M (M1)	Fiber Optic Cable
External compact TTL strobe		
External compact manual strobe	M (M2)	Fiber Optic Cable
Manual flash trigger		
Optical Converter (manual mode)		
2-pin connector (sync connector)	M (M2)*	Syncro code

*M2 is automatically selected when the power is turned on with the sync cord connected to the strobe.

TTL撮影

Camera side	Mode switch	Connection cord
Built-in camera flash	TTL	Fiber Optic Cable
External compact TTL strobe		
Optical converter (TTL mode)		

RC撮影

Camera side	Mode switch	Connection cord
RC-compatible camera built-in flash (RC mode)	RC	Fiber Optic Cable
RC-compatible external compact strobe (RC mode)		

⚠️ 注意

- When a sync cord is connected to this product, the automatic recognition function is activated and the product cannot be used even if a fiber-optic cable is connected.

Connect with fiber optic cable

To make this product emit light using the light from the camera's built-in flash, connect it to the camera with a fiber-optic cable (optional). When connected to a camera with a fiber-optic cable, this product senses the light from the camera's built-in flash and emits light in sync with it.

⚠ Caution

- Be aware that some housings may not be able to connect the fiber-optic cable.
- Be sure to do this with the strobe power OFF.

1 Insert the fiber-optic cable connector into the fiber-optic socket (optical sensor) until it stops

- When an optical fiber is inserted into the fiber-optic socket for additional light, it will not emit light correctly.

⇒ Fiber-optic sockets (for additional light)"
(P.E-21)

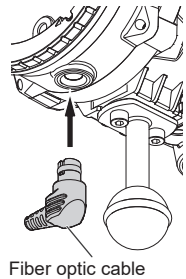

2 Thread fiber-optic cable through hooks for fiber optics

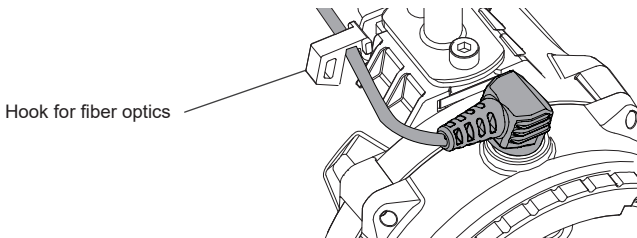

4 Connect the connector of the fiber-optic cable to the plug of the housing

- If the housing does not have a direct fiber-optic cable connection (no fiber-optic cable socket), attach a strobe mask (A: optional) to the flash window and connect the fiber-optic cable (B: optional) is connected.

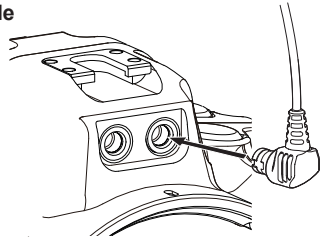
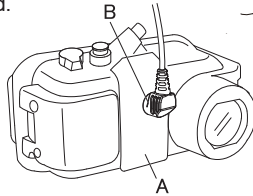

⚠ Caution

- When shooting, be sure to set the camera's built-in flash to the forced-flash mode. If the camera's built-in flash does not fire, this product will not fire either. For details on how to set the forced-flash mode, please refer to your camera's instruction manual.
- Before using the product, be sure to read the instruction manual for the fiber-optic cable and housing carefully.

Fiber-optic sockets for additional light

This product can be used as a main strobe to increase the number of strobes. Connect the fiber-optic cable between the fiber-optic cable socket of the main strobe and the light receiving sensor of the strobe to be augmented.

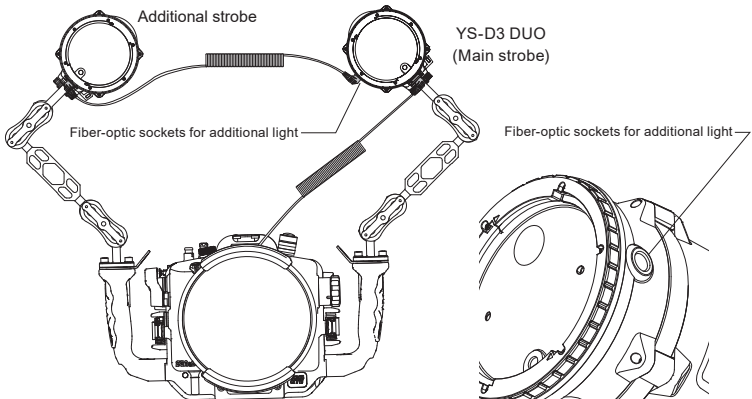

Connect with a sync cord

When using this product with a camera housing equipped with a strobe connector/converter connector, use a sync cord (optional) to connect.

- 1 Remove the connector cap of the sync cord and check the O-ring (strobe side/camera/housing side)
 - Make sure there are no scratches, debris, etc., and apply a thin layer of silicon grease.

- 2 Remove strobe connector cap

⚠ Caution

- The synchro cord must be installed with the power turned off; otherwise, it may emit a false light.

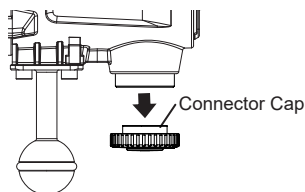

- 3 Align the convex part of the strobe's connector with the concave part of the sync cord's connector and plug it straight in

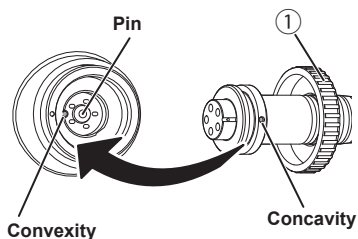

- 4 Align ① with the strobe screw and turn until it stops.

- Tighten the screws securely.
- When disconnecting the sync cord, loosen ①, hold the base of the sync cord connector, and pull it straight out.
- Do not pull on the cord.

- 5 Remove the housing connector cap

- 6 Align the circle mark on the sync cord (or the concave part at the tip) with the circle mark on the strobe connector (or the convex part inside) and insert it straight into the strobe.

- 7 Align B on the sync cord with the strobe connector screw and turn until it stops.

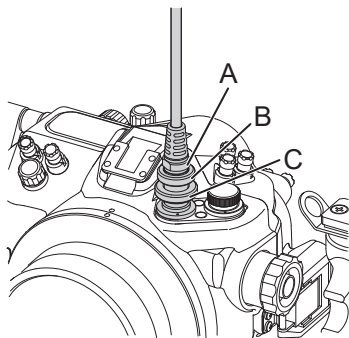

8 Turn C of the sync cord until it stops.

- Tighten the screws securely.
- When removing the sync cord, loosen C and B in this order, then hold A and pull it straight out.
- Do not pull on the cord.

Caution

- Do not touch the connector terminals with your fingers. Do not allow silicon grease to adhere to the metal terminals of the connector. If silicon grease should adhere to the connector, clean it with alcohol.
- When disconnecting the sync cord, be sure to attach the connector cap to protect the connector.
- Be sure to attach the connector cap to the synchro cord to protect the connector when the synchro cord is disconnected and washed in water.
- Be sure to read the instruction manual for the synchro cord carefully before use.

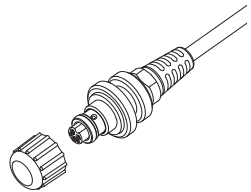

Quick Setup Guide

Depending on your shooting style, you may need to change camera/flash settings. Please refer to the following to confirm the necessary settings.

Fiber-optic cable connection : TTL dimming shooting only or both TTL dimming/manual dimming shooting

Camera used : RC mode compatible

1. Set the camera to RC mode
2. No need to change the settings of this strobe
Use the mode switch in RC (character emission color: red).
Customize mode: RC channel/group setting changes can be made if needed.

Camera used : RC mode not supported

1. Set camera/TTL converter to TTL
2. Check the list of pre-flash cancel settings and light input settings of the camera in use and change the settings of this strobe.

⇒ List of settings by camera" (P.E-44)

- When the camera is set to [A (factory default)] + [Mode 10 (factory default)]
No need to change this strobe setting
 - When the camera used is not [A (factory default)] + [Mode 10 (factory default)]
Customize mode ⇒ Change the light input setting
 - When the camera used is other than [A (factory default)] + [Mode 10 (factory default)]
Customize mode ⇒ Change the pre-flash cancel setting.
 - When the camera used is other than [A (factory default)] + other than [Mode 10 (factory default)]
Customize mode ⇒ Change the pre-flash cancel setting
Customize mode ⇒ Change light input setting
3. Change of settings completed
TTL mode : Set the mode switch to DS-TTL (text flash color: blue).
Manual mode : Set the mode switch to Manual 1 (factory default setting, text emission color: orange).

Fiber-optic cable connection : Manual dimming only

1. Set camera/strobe/TTL converter to manual mode
2. Change this strobe to Manual 2 mode
(1) Set the mode switch to [M] (factory setting, manual 1, character emission color: orange)
(2) Press and hold the target light button and change to Manual 2 (text emission color: green)
3. Change of settings completed
Use the mode switch at [M]/[Manual 2] (character emission color: green).

Sync cord connection

1. set the camera to manual mode
2. no need to change the settings of this strobe
Use the mode switch at [M] (character emission color: green).

⇒ Customize Mode" (P.E-31)

Take a picture

Caution

- If this product is used to emit light continuously, a protection circuit will be activated to limit the amount of light emitted.
Please stop using the product until the lamp returns from blinking yellow to lit green.
- Do not use the product with the light-emitting part of the product covered.
- Do not look directly at the light-emitting part of the product.

When connected via fiber-optic cable

When shooting with a digital camera, be sure to set the camera's built-in flash to the forced-flash mode. If the camera's built-in flash does not fire, this product will not fire either.

Caution

- The red-eye reduction function should be deactivated.
- The camera's built-in flash should be set to not emit AF auxiliary light.

DS-TTL mode shooting

Effective when there is an optical converter or camera's built-in flash or another strobe connected to the camera. Please check the compatible models.

- Before shooting, please set the pre-flash cancel and light input settings according to your photographic equipment.

 See P.E-44 for details.

- 1 Set the mode switch to [TTL].
- 2 Adjust the light intensity control dial.
- 3 Shooting

Caution

- When using this product with a sync cord connected to an SLR housing or other equipment, DS-TTL cannot be used.
- To shoot with DS-TTL, you need to use an optical converter or use the camera's built-in flash or another TTL strobe connected to the camera. When connected to a strobe, DS-TTL cannot be used if the strobe does not pre-flash.
- The compensation using the light level control dial may not be effective depending on the shooting conditions or camera settings.

RC mode shooting

To shoot in RC mode with a camera equipped with an RC system, set the camera to RC mode.

- 1 Set the mode switch to [RC].**
- 2 Adjust the light intensity on the camera side.**
 - The strobe's light intensity control dial can also be used.
- 3 Shooting**

- Channel and group settings can be made in the customize mode.



⇒ See P.E-34 for details.

Manual Shooting

Use the light level control dial to adjust the flash output for shooting.

1 Set the mode to Manual 1 [] or Manual 2 [].

*Long press of the target light button alternates the mode.

- Set to [] when shooting with a digital camera that has a pre-flash function.
- Select [] when shooting with a digital camera that does not have a pre-flash function.

2 Adjust the light intensity control dial.

3 Shooting

Confirmation of mode

You can check if the mode setting is correct by shooting this product with a digital camera. In addition, the built-in flash pattern of a digital camera may change depending on the shooting mode. When the shooting mode of the camera is changed, check the mode switch setting again.

1 Set the camera in the housing with the built-in flash set to forced-flash mode, and connect this product with the fiber-optic cable.

2 Set the mode switch of the product to [] and the light intensity control dial to [33], and take a picture of the light emitting part of the product from the front.

- Be sure to use the camera's built-in flash.

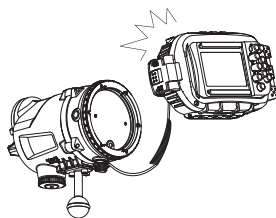

3 Check the images you have taken.

- If the light-emitting area of the product is white or the entire screen is pure white, the setting is correct (synchronized).
- If the light emitting area is dark (not in sync), change the pre-flash cancel setting (5 types available) in the Customize mode, take another picture of the product from the front of the light emitting area, and check the image. (P.J-30)

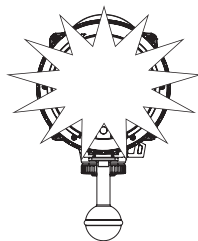

When connected with a synchro cord

Manual Shooting

Use the light level control dial to adjust the flash output for shooting.

- 1 Turn mode switch to [M].
- 2 Adjust the light intensity control dial.
- 3 Shooting

When a sync cord is connected, the mode is fixed to Manual 2 [⚡].

Use a diffuser

A diffuser is included with this product. Please use it according to your photographic application.

- GN:28 (FULL Luminescence) , Angle of illumination : 100°×110°

Install

- 1 Thread the included diffuser strap through the strap hole on the product.

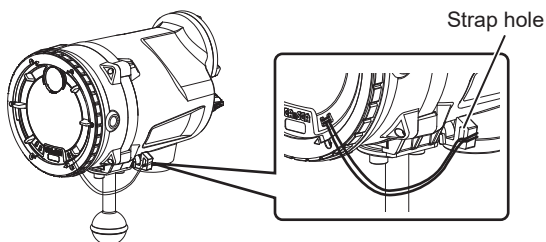

- 2 Set the diffuser on the strobe body

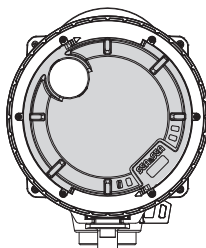

- 3 Turn the diffuser clockwise and set it firmly until it clicks into place.

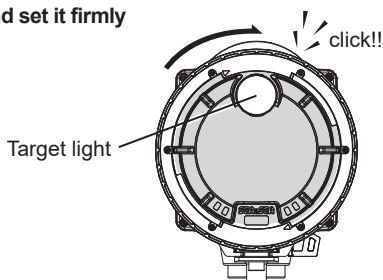

⚠ Caution

- Make sure that the diffuser is properly installed before use. Failure to do so may cause the diffuser to drop out, get lost, or break during use.

Detach

- 1 Turn the diffuser counterclockwise and remove it.

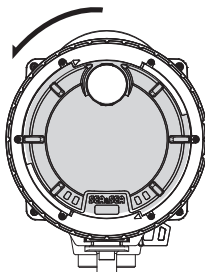
**Shooting Tip!**

- When shooting in bright locations, the camera tends to overexpose the image. If the camera's exposure compensation cannot fully adjust the exposure, lower the camera's ISO sensitivity or extend the length of the arm to minimize the distance between the product and the subject.
- When used in conjunction with other products such as LED lights, the camera may overexpose the image due to the mixed light. Turn off the light when taking macro shots, especially when shooting close up to the subject.

Customize mode

[DS-TTL] Pre-flash cancel setting

This setting is required for Optical DS-TTL and Manual 2 shooting.

- 1 Make sure the mode switch is set to OFF.
- 2 Turn the light intensity control dial to the "5.6" position.
- 3 While holding down the target light button, turn the mode switch to [TTL].
- 4 The panel blinks blue and the DS-TTL setting starts.
- 5 Release the target light button.

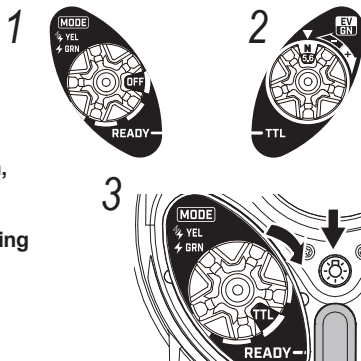

- Set the strobe according to the camera.

➡ See P.E-44 for details.

- 6 Turn the light intensity control dial to the desired mode.
- 7 Press and hold the target light button to determine the mode.
- 8 The buzzer sounds and the READY/TTL lamp turns blue to complete the setting.

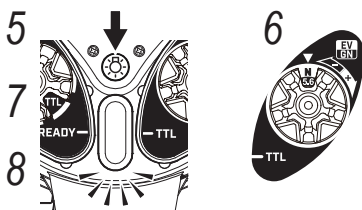

*If the light turns red, the setting has failed.
Please try the setting again.

Light level control dial and pre-flash cancel mode

Change the light intensity adjustment dial to the position shown in the table at right, and press the target light button to change to the mode shown in the table at right.

Light Quantity Adjustment Dial	Mode
1	A (Factory Default)
2	B
5.6	C
16	D
33	E

- 9 Turn the mode switch to turn the power OFF.
- 10 The settings are saved and the customize mode is closed.

【DS-TTL】Optical input setting

- 1 Make sure the mode switch is set to OFF.
- 2 Turn the light intensity control dial to the "5.6" position.
- 3 While holding down the target light button, turn the mode switch to [TTL].
- 4 The panel blinks blue and the DS-TTL setting starts.
- 5 Release the target light button.
- 6 Turn the mode switch to "RC".
- 7 Turn the light level control dial to adjust to the light input setting mode.

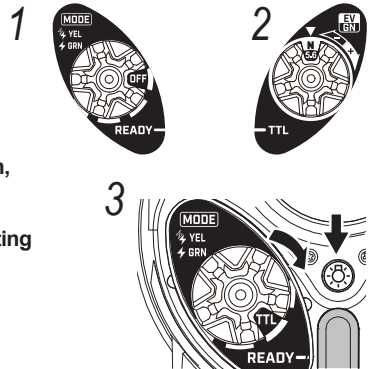

⇒ See P.J-33/44 for details.

- 8 Press and hold the target light button to determine the light input setting mode.
- 9 The buzzer sounds and the READY/TTL lamp turns blue to complete the setting.

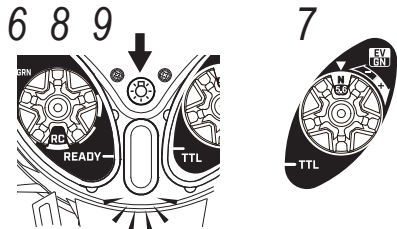

*If the light turns red, the setting has failed.
Please try the setting again.

- 10 Turn the mode switch to turn the power OFF.
- 11 The settings are saved and the customize mode is closed.

Light level control dial and light input mode

Change the light intensity adjustment dial to the position shown in the table at right, and press the target light button to change to the mode shown in the table at right.

Light Quantity Adjustment Dial	Mode
1	10 (Factory Default)
1.4	14
2	20
2.8	28
4	40
5.6	56
8	80
11	110
16	160
22	220
33	330

[RC mode] Channel number setting

- 1 Make sure the mode switch is set to OFF.
- 2 Turn the light intensity control dial to the "5.6" position.
- 3 While holding down the target light button, turn the mode switch to [RC].
- 4 The panel flashes red and the RC mode setting is initiated.
- 5 Release the target light button.
- 6 Turn the mode switch to "TTL".
- 7 Turn the light level control dial to the desired channel.
- 8 Press and hold the target light button.
- 9 The buzzer sounds and the READY/TTL lamp turns blue to complete the setting.

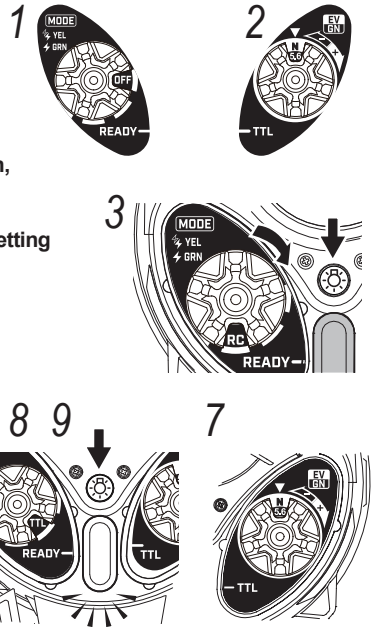

*If the light turns red, the setting has failed.
Please try the setting again.

Light level control dial and channel number

Change the light intensity adjustment dial to the position shown in the table at right, and press the target light button to change to the mode shown in the table at right.

Light Quantity Adjustment Dial	Channel
1	1 (Factory Default)
2	2
2.8	3
4	4

- 10 Turn the mode switch to turn the power OFF.
- 11 The settings are saved and the customize mode is closed.

[RC mode] Group settings

- 1 Make sure the mode switch is set to OFF.
- 2 Turn the light intensity control dial to the "5.6" position.
- 3 While holding down the target light button, turn the mode switch to [RC].
- 4 The panel flashes red and the RC mode setting is initiated.
- 5 Release the target light button.
- 6 Turn the mode switch to "RC".
- 7 Turn the light intensity control dial to the desired group.
- 8 Press and hold the target light button.
- 9 The buzzer sounds and the READY/TTL lamp turns blue to complete the setting.

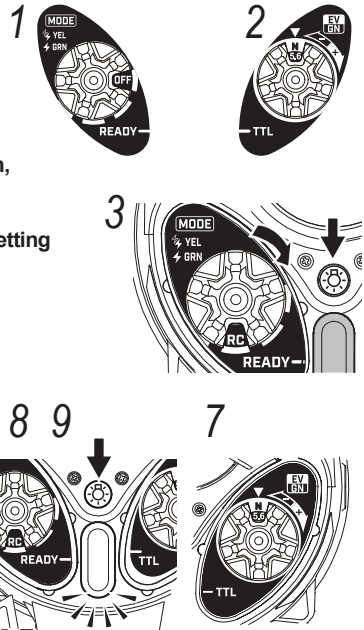

*If the light turns red, the setting has failed.
Please try the setting again.

Light Quantity Adjustment Dial and Group

Change the light intensity adjustment dial to the position shown in the table at right, and press the target light button to change to the mode shown in the table at right.

Light Quantity Adjustment Dial	Group
1	Group A (Factory Default)
5.6	Group B
33	Group C

- 10 Turn the mode switch to turn the power OFF.
- 11 The settings are saved and the customize mode is closed.

[System] Buzzer/panel light setting

- 1 Make sure the mode switch is set to OFF.
- 2 Turn the light intensity control dial to the "5.6" position.
- 3 While holding down the target light button, turn the mode switch to [M].
- 4 The panel flashes white and the system setup begins.
- 5 Release the target light button.
- 6 Turn the mode switch to "TTL".
- 7 Turn the light intensity control dial to the desired mode.
- 8 Press and hold the target light button.
- 9 The buzzer sounds and the READY/TTL lamp turns blue to complete the setting.

*If the light turns red, the setting has failed.
Please try the setting again.

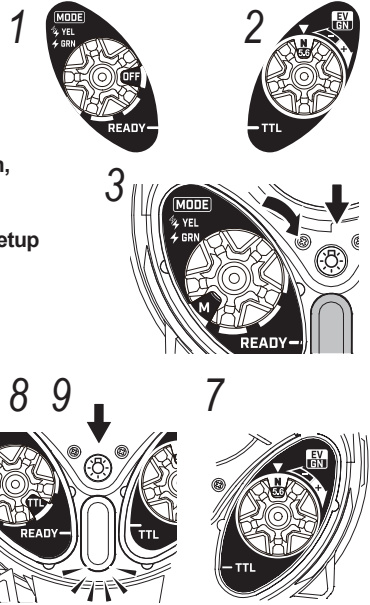

Light level control dial and buzzer/panel setting

Change the light intensity adjustment dial to the position shown in the table at right, and press the target light button to change to the mode shown in the table at right.

Light Quantity Adjustment Dial	Mode
1	Buzzer off
4	Buzzer on (Factory Default)
8	Panel lighting off
33	Panel lighting on (Factory Default)

- 10 Turn the mode switch to turn the power OFF.
- 11 The settings are saved and the customize mode is closed.

[System] Auto power off/Sleep setting

Auto power off

To reduce power consumption, the power is automatically turned off when there is no signal input for a certain period of time. To resume use, turn the power back on.

Sleep

To reduce power consumption, the READY/TTL lamp blinks in light blue when there is no signal input for a certain period of time, and the unit enters the power-saving mode. When a signal input is received, the mode returns to normal.

- 1 Make sure the mode switch is set to OFF.
- 2 Turn the light intensity control dial to the "5.6" position.
- 3 While holding down the target light button, turn the mode switch to [M].
- 4 The panel flashes white and the system setup begins.
- 5 Release the target light button.
- 6 Turn the mode switch to "M".
- 7 Turn the light intensity control dial to the desired mode.
- 8 Press and hold the target button.
- 9 The buzzer sounds and the READY/TTL lamp turns blue to complete the setting.

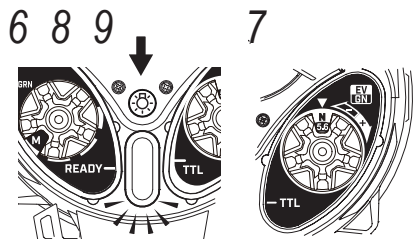
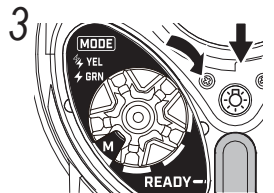

*If the light turns red, the setting has failed.
Please try the setting again.

Light level control dial and auto power off setting

Change the light intensity adjustment dial to the position shown in the table at right, and press the target light button to change to the mode shown in the table at right.

Light Quantity Adjustment Dial	Auto power off
1	5分
1.4	10分
2	30分
2.8	60分 (Factory Default)
4	None

Light level control dial and sleep setting

Change the light intensity adjustment dial to the position shown in the table at right, and press the target light button to change to the mode shown in the table at right.

Light Quantity Adjustment Dial	Sleep
8	5 min.
11	10 min.
16	30 min.
22	60 min.
33	None (Factory Default)

10 Turn the mode switch to turn the power OFF.

11 The settings are saved and the customize mode is closed.

[System] Resetting the settings (Restore factory defaults)

- 1 Make sure the mode switch is set to OFF.
- 2 Turn the light intensity control dial to the "5.6" position.
- 3 While holding down the target light button, turn the mode switch to [M].
- 4 The panel flashes white and the system setup begins.
- 5 Release the target light button.
- 6 Turn the mode switch to "RC".
- 7 Turn the light intensity control dial to the "33" position.
- 8 Press and hold the target light button.
- 9 The buzzer sounds, the READY/TTL lamp lights up light blue and then turns off, and the power turns off.

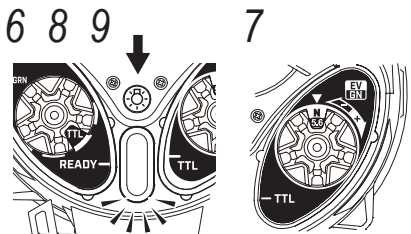
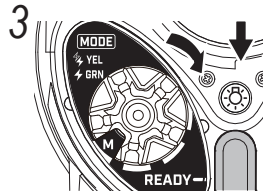
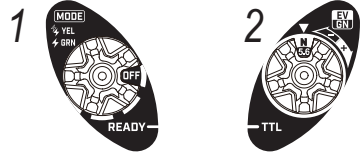

*If the light turns red, the setting has failed.
Please try the setting again.

- 10 Reset completed.

Care and storage precautions

⚠ Caution

- After use, be sure to soak the product in fresh water thoroughly as shown in the illustration under waterproof conditions, and then wash it under running water. Wash moving parts (levers, buttons, etc.) while moving them. Do not move the battery cap when washing.

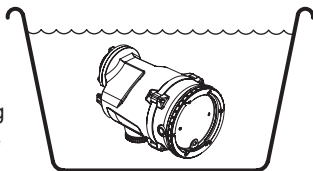

- If the product is not sufficiently soaked in fresh water or simply rinsed under running water, salt will remain, and as it dries, the salt will crystallize and will not dissolve easily in water. Salt crystals adhering to the product are very difficult to remove and may cause flooding, so be sure to soak the product thoroughly in fresh water.
- After washing the product in water, wipe it dry with a soft, dry cloth and hang it in the shade to dry.
- Do not use heat-generating equipment to force dry the product, as this may cause deformation or damage to the product.
- When not using the product for a long period of time, please store it away from high temperatures, high humidity, direct sunlight, and extremely cold temperatures.
- After using the product, remove the battery from the product and store it in a safe place.
- After use, please maintain the O-rings before storing them. We recommend that you inspect the O-rings before and after use and replace them as soon as possible.
- Although it depends on the frequency of use and storage conditions, we recommend that you have the product overhauled (for a fee) once every two years after purchase in order to maintain the performance of the product.
- If the camera is not to be used for a long period of time, please insert the battery or batteries and perform a test flash once a month to prevent deterioration of the internal electronic parts. Also, operate the controls in the same way as when actually shooting.

Troubleshooting

Please check the following items. If the condition does not improve after checking the following items, please contact our customer service.

READY/TTL lamp does not light

- Is the battery inserted? (P.E-17)
- Are the batteries facing the right way? (P.E-17)
- Are old batteries being used? (P.E-17)
- Is the battery cover securely closed? (P.E-18)
- If the light is emitted continuously, the internal protection circuit will be activated. Turn off the power and leave the product in a cool place for a while before use.
- If the product is left in a high temperature place, the internal protection circuit will be activated. Please leave the product in a cool place for a while before use.

Connect with synchro cord

No luminescence

- Is the sync cord firmly connected? (P.J-18)
- Is the metal pin of the connector rusted? If rusted or damaged, contact our customer service.

Connected by fiber-optic cable

No luminescence

- Is the fiber-optic cable firmly connected? (P.J-20)
- Is the camera's built-in flash/main strobe firing? (P.J-23)
- Is the TTL converter or optical sync unit firing? (P.J-23)
- If a sync cord is attached, the strobe will not fire. Please unplug the sync cord before use. (P.J-18)

The image taken is dark although the light is flashing in manual shooting.

- Is the flash mode of the camera's built-in flash/main strobe compatible with that of the YS-D3 DUO? (P.J-23)
- For details, please refer to the "Customize" section of the YS-D3 DUO introduction page on our website.



Image taken in DS-TTL mode is too bright/dark

- Is the fiber-optic cable firmly connected? (P.E-21)
- Is the light level control dial set to +/- compensation in DS-TTL mode? (P.E-13)
- The correction with the light level control dial may not be effective depending on the shooting conditions or camera settings.

Automatically turns off

- Auto power off mode is activated. To turn on the power again, set the mode switch to [OFF] once and then set the desired mode. (P.E-13)

Specification

Control section	Mode switch (OFF /  /  / DS-TTL) Target light switch (ON HIGH / ON LOW / OFF) Light level control dial
Operation indication	READY lamp (LED lights red when charging is complete) TTL lamp (LED lights green for about 2 seconds when auto-dimming is activated)
Guide No.	33 (with FULL flash) 28 (with diffuser)
Illumination angle	80°×105° 100°×110° (When using diffuser)
Color temperature	5800°K 5500°K (When using diffuser)
Number of luminous flashes*1	Alkaline AA batteries: approx. 140 times Ni-MH AA batteries: approx. 220 times*2
Recycle Time*2	Alkaline AA batteries: approx. 3.5 sec. Ni-MH AA batteries: approx. 1.7 sec.
Usable battery	1.5V alkaline AA batteries x 4 1.2V Ni-MH AA battery x 4
Operating temperature	1°C~40°C
Body Material	Polycarbonate resin, ABS resin
Pressure seismic intensity	100m
Size	W92×H111×D147 (Ball base not included)
Mass	610 g (Main unit only, batteries and ball base not included)
Submerged mass	-20g (Batteries and ball base included)
Accessories	Diffuser, Ball mount, Silicone grease

*1 Number of emissions and recycle time are values at FULL emission and vary depending on battery manufacturer, temperature, and frequency of use.

*2 Data values for the number of flashes and recycle time of Ni-MH batteries were measured using 1900mAh (eneloop).

List of settings by camera

Shooting in RC mode

When shooting in RC mode with an OM SYSTEMS (OLYMPUS) camera, no custom settings are required. Select "RC mode shooting" in the flash mode setting on the camera side; YS-D3 DUO should be set to "RC" for shooting mode.

*For details on "RC mode shooting," please refer to the user's manual of the camera to be used.

Shooting with DS-TTL using an optical/TTL converter

List of strobe settings (TTL converter)

(As of August 2023.8)

Meier	TTL converter	Converter Setting	Camera	Pre-flash cancel setting	Optical input setting
SEASSEA	Optical converter for MDX-N1	D2 mode D3E mode	D850	A (Default setting)	mode 56
			D810		
			D800		
			D700		
			D600		
			D500		
			D7200		
			D7100		
			D7000		
			D78		
	288	A (Default setting)	mode 10 (Default setting)		
	27				
	Optical converter for MDX-C2	D2 mode D3E mode	26	A (Default setting)	mode 80
			SCM33		
			SCM32V		
	Optical converter for MDX-GR	D1	10MKS2	A (Default setting)	mode 28
			R		
	Optical converter for MDX/S1 Optical converter for MDX/S2	D2 mode(S1) D3E mode(S2)	R	A (Default setting)	mode 28
			85		
			a1		
a85					
a752					
a753					
a753E					
a762					
a76V					
a76V					
a78					
a7V					
NAUTICAM	NA TTL converter Nikon	ch1	-	A(Default setting)	mode 10 (Default setting)
	NA TTL converter Canon (Small strobe)	-	-	A(Default setting)	mode 220
	NA TTL converter S sony FE	ch6	-	A (Default setting)	mode 10 (Default setting)
	NA TTL converter S sony C	ch6	-		
	NA TTL converter S sony E	ch6	-		
AOI	RC commander	-	-	A(Default setting)	mode 10(Default setting)

Shooting in DS-TTL/Manual using the built-in flash

List of strobe settings (camera's built-in flash)

(As of August 2023.8)

【Canon】

	Camera	Camera flash setting	Strobe mode dial	Pre-flash cancel setting	Optical input setting
Compact digital camera	ZY 410E *1 *2	Forced luminescence	manual 1 / TTL	A(Default setting)	mode 10(Default setting)
	Power Shot SX230HS *2				
	Power Shot S100				
	Power Shot G1 X *2				
	Power Shot D20				
	Power Shot S110 *2				
	Power Shot G15 *2				
	Power Shot S120 *2				
	Power Shot G16 *2				
	Power Shot G1 X Mark II				
	Power Shot G7 X				
	Power Shot G7 X Mark II				
Power Shot G9 X Mark II					
DSLR	KissX2	Forced luminescence	manual 1 / TTL	A(Default setting)	mode 160
	KissX3				
	KissX4				
	KissX5				
	KissX6i				
	KissX7i				
	KissX7				
	KissX8i				
	Kiss X9i				
	T0				
	T0MKII				
	T00				
R00					
Mirrorless cameras	M5	Forced luminescence	manual 1 / TTL	A(Default setting)	mode 160
	R50				

*1 MENU ⇒ Stroke Control ⇒ Auto Red-eye Correction should be set to "OFF".

*2 When the strobe mode is set to M, the camera's built-in flash will fire manually without pre-flash, so set the mode dial to E.

DS-TTL and DS-TTL II may not work properly with housings made by other manufacturers due to the position of the fiber-optic cable. Please check with the housing manufacturer in advance for compatibility.

General settings and cautions for strobe photography

- The camera's built-in flash should be set to the forced-flash mode. The red-eye reduction setting should be turned off.

- The DS-TTLLE function cannot be used when the camera's built-in flash is set to manual flash (flash without pre-flash).

- Please turn off the function on cameras that use the built-in flash for auxiliary light for AF. (Mainly Canon cameras)

- The ISO setting is 100 or 200 when the camera is checked for compatibility. If the ISO sensitivity is set to auto or higher, the amount of light emitted may be reduced and the brightness may not be appropriate.

- When a fiber-optic cable deteriorates and the light transmitted to the strobe is reduced due to a broken core in the cable sheath, etc., the strobe does not dim properly, does not fire at full intensity, or does not fire at all.

- We do not perform firmware verification of all cameras. We select the models to be verified based on our standards. If you wish to update your camera, please contact us for further information.

ストロボ設置一覧(カメラ内蔵フラッシュ)

【Nikon】

(As of August 2023.8)

	Camera	Camera flash setting	Strobe mode dial	Pre-flash cancel setting	Optical input setting
DSLR	D7000	Forced luminescence	manual 1 / TTL	A(Default setting)	mode 330
	D7100				
	D7200				
	D300S				
	D600				
	D610				
	D700				
	D800/D800E				
	D810				
	Nikon1 J1/J2				
	Nikon1 J4				
Mirrorless cameras	Nikon1 J3	Forced luminescence	manual 1 / TTL	C	mode 330
	Nikon1 S1	Forced luminescence	manual 1 / TTL	D	mode 330

*DS-TTL and DS-TTL II may not work properly with housings made by other manufacturers due to the position of the fiber-optic cable. Please check with the housing manufacturer in advance for compatibility.

General settings and cautions for strobe photography

- The camera's built-in flash should be set to the forced-flash mode. The red-eye reduction setting should be turned off.

- The DS-TTLLE function cannot be used when the camera's built-in flash is set to manual flash (flash without pre-flash).

- For cameras that use the built-in flash for auxiliary light for AF, please turn off the function.

- The ISO setting is 100 or 200 when the camera is checked for compatibility. If the ISO sensitivity is set to auto or higher, the amount of light emitted may be reduced and the brightness may not be appropriate.

- When a fiber-optic cable deteriorates and the light transmitted to the strobe is reduced due to a broken core in the cable sheath, etc., the strobe does not dim properly, does not fire at full intensity, or does not fire at all.

- We do not perform firmware verification of all cameras. We select the models to be verified based on our standards. If you wish to update your camera, please contact us for further information.

List of strobe settings (camera's built-in flash)

(As of August 2023.8)

[Sony]		Camera	Camera flash setting	Strobe mode dial	Pre-flash cancel setting	Optical input setting
Compact digital camera	RX100	Forced luminescence	manual 1 / TTL	A(Default setting)	mode 14	
	RX100 II					
	RX100 III					
	RX100 IV					
Mirrorless cameras	RX100 V	Forced luminescence	manual 1 / TTL	A(Default setting)	mode 80	
	α6000					
	α6300					
	α6500					

DS-TTL and DS-TTL II may not work properly with housings made by other manufacturers due to the position of the fiber-optic cable. Please check with the housing manufacturer in advance for compatibility.

General settings and cautions for strobe photography

- The camera's built-in flash should be set to the forced-flash mode. The red-eye reduction setting should be turned off.
- The DS-TTL II function cannot be used when the camera's built-in flash is set to manual flash (flash without pre-flash).
- For cameras that use the built-in flash for auxiliary light for AF, please turn off the function.
- The ISO setting is 100 or 200 when the camera is checked for compatibility. If the ISO sensitivity is set to auto or higher, the amount of light emitted may be reduced and the brightness may not be appropriate.
- When a fiber-optic cable deteriorates and the light transmitted to the strobe is reduced due to a broken core in the cable sheath, etc., the strobe does not fire at full intensity, or does not fire at all.
- We do not perform firmware verification of all cameras. We select the models to be verified based on our standards. If you wish to update your camera, please contact us for further information.

List of strobe settings (camera's built-in flash)

(As of August 2023.8)

[Panasonic]		Camera	Camera flash setting	Strobe mode dial	Pre-flash cancel setting	Optical input setting
Mirrorless cameras	DMC-GH4	Forced luminescence	manual 1 / TTL	C	mode 10(Default setting)	
	DC-GH5					

[Ricoh]

[Ricoh]		Camera	Camera flash setting	Strobe mode dial	Pre-flash cancel setting	Optical input setting
	リコー	GR DIGITAL II	Forced luminescence	manual 1 / TTL	A (Default setting)	mode 10 (Default setting)
	RICOH					

[Fujifilm]

[Fujifilm]		Camera	Camera flash setting	Strobe mode dial	Pre-flash cancel setting	Optical input setting
Compact digital camera	フイルム	Forced luminescence	manual 1 / TTL	A(Default setting)	mode 10(Default setting)	
	X10					
	X20					
	X201					
Mirrorless	X202	Forced luminescence	manual 1 / TTL	A(Default setting)	mode 10(Default setting)	
	X-H1/EF-X8					

[SEA&SEA]

[SEA&SEA]		Camera	Camera flash setting	Strobe mode dial	Pre-flash cancel setting	Optical input setting
Compact digital camera	1G	Forced luminescence	manual 1 / TTL	A(Default setting)	mode 10(Default setting)	
	2G					
	8G	Forced luminescence	manual 1 / TTL	E	mode 10(Default setting)	

DS-TTL and DS-TTL II may not work properly with housings made by other manufacturers due to the position of the fiber-optic cable. Please check with the housing manufacturer in advance for compatibility.

General settings and cautions for strobe photography

- The camera's built-in flash should be set to the forced-flash mode. The red-eye reduction setting should be turned off.
- The DS-TTL II function cannot be used when the camera's built-in flash is set to manual flash (flash without pre-flash).
- For cameras that use the built-in flash for auxiliary light for AF, please turn off the function.
- The ISO setting is 100 or 200 when the camera is checked for compatibility. If the ISO sensitivity is set to auto or higher, the amount of light emitted may be reduced and the brightness may not be appropriate.
- When a fiber-optic cable deteriorates and the light transmitted to the strobe is reduced due to a broken core in the cable sheath, etc., the strobe does not fire at full intensity, or does not fire at all.
- We do not perform firmware verification of all cameras. We select the models to be verified based on our standards. If you wish to update your camera, please contact us for further information.

Operation in case of warning or abnormality

Condition	Lamp display	Buzzer operation	Details
Charge Complete /Battery Level Warning	Yellow light	Rings for 0.5 seconds	
Luminous failure	Red light on (for 1 sec.)		
During luminescence limitation (temperature limitation)	Yellow Slow Flashing		The light-emitting operation is temporarily stopped because the internal temperature has reached or exceeded the specified value. When the temperature drops to the default value, the lamp display turns green and light-emitting operation is resumed.
Light emission restricted (light input restricted)	Yellow Slow Flashing		The light-emitting operation is temporarily stopped due to an abnormal input to the light center from a large sun light or room light. When the light input becomes normal, the lamp display turns green and light-emitting operation is resumed.
No battery power left	Flashing yellow (for 10 seconds)		Low battery condition; auto power off after 10 seconds.
Abnormality (during power-on/operation)	Flashing red (for 10 seconds)	Rings for 10 seconds at 1 second intervals	Internal abnormality detected; auto power off after 10 sec.

SEA&SEA