

# Attaching the Optional Accessories

## ERGO GRIP Ver.2

Optional Ergo Grip Set ver.2 (#22137) can be attached to the housing using accessory Grip Brackets R and L.



- 注意**
- When fitting the Ergo Grip Set ver. 2 you must also use the accessory Grip Brackets without fail. Fitting the Ergo Grip Set ver. 2 without using the Grip Brackets will result in accidents such as water leakage and possible injury.

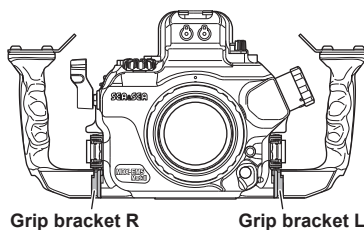

Grip bracket R

Grip bracket L

### Accessories

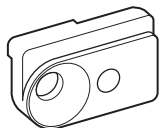

Grip bracket R ×1

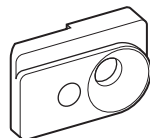

Grip bracket L ×1



Bolt A ×2

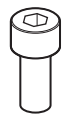

Bolt B ×2



Hex wrench ×1  
(for Bolt A)

### Identification of Parts

#### Grip bracket R

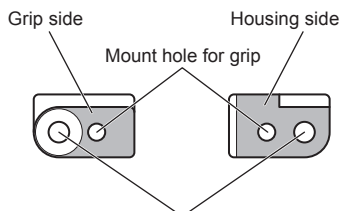

Mount hole for housing

#### Grip bracket L

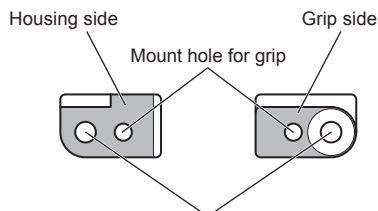

Mount hole for housing

### How to Attach to the Housing

#### 1 Fit the Grip brackets R and L



#### CAUTION

- Use the accessory hex wrench included.
- Correctly fit the Grip brackets as shown in the figure.

#### <Attaching the Grip bracket L>

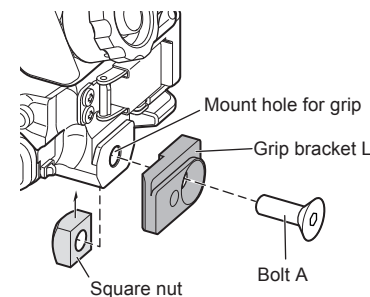

#### 2 Firmly fix the Ergo Grip Set ver.2 to the Grip Brackets as shown



#### CAUTION

- Use the accessory hex wrench.
- Pay attention to correctly locate washer washers A and B.

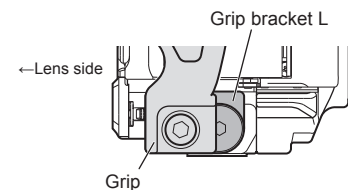
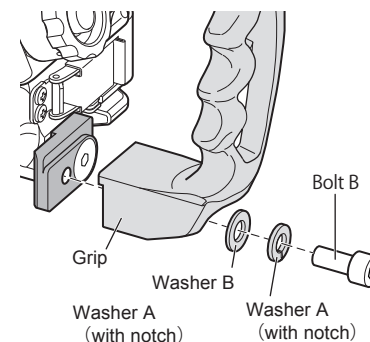

#### CAUTION

- After installation, check to make sure grip is securely fasten to the grip bracket and housing. Any unstable installation may caused the screws to loosen which may dislodge the grip resulting to damage and serious injuries.