

*UNDERWATER HOUSING for  
Canon EOS 5D Mark III / EOS 5D Mark IV*

# ***MDX-5D Mark IV***

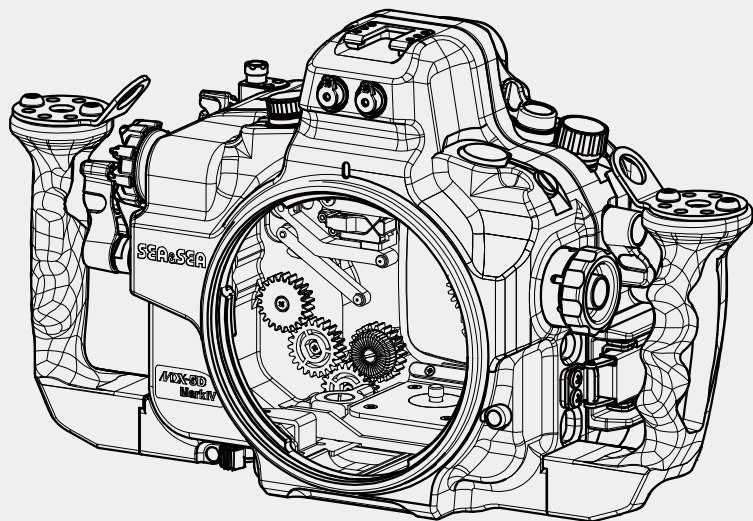

**取扱説明書  
Instruction Manual**

## **Introduction**

Thank you for purchasing SEA&SEA products.

Please read this instruction manual carefully prior to using this product. Only with a thorough understanding of this manual's content will you be able to use the housing correctly. After reading the manual, please be sure to keep it in a place where you can easily come back to it at any time.

### **Note:**

**This products have passed SEA&SEA's  
criteria-based inspection for pressure resistance.**

The appearance of color evenness or weld lines on the external body of the product is normal and will not affect its performance.

## **Contents**

Safety Precautions .....	E-2
Precautions on Handling the O-ring .....	E-4
Identification of Parts .....	E-6
Preparation for Setting Up .....	E-8
Prepare the housing and port .....	E-8
Prepare the digital camera .....	E-8
Prepare the connecting accessories .....	E-8
Opening and Closing the Housing .....	E-9
Attaching and Detaching the Port .....	E-11
Mounting the Camera in the Housing .....	E-13
Connecting the Strobe .....	E-15
External Controls .....	E-16
Attaching the Optional Accessories .....	E-20
Maintenance and Storage .....	E-24
Specifications .....	E-25

# Safety Precautions

For safe handling of the product, please read the following precautions carefully before use.

Failure to heed the precautions listed below could result in serious consequences. To prevent injury or damage to yourself and/or others, please observe the precautions as they contain highly important information related to personal and product safety.

 **WARNING** Situations that could result in severe injury or death.

 **CAUTION** Situations that could result in property damage or personal injury.

## **WARNING**

- Keep out of reach of children to prevent accidental ingestion. If swallowed, seek medical advice immediately.

## **CAUTION**

- Carefully observe the instruction manual for the compatible camera for this product before use.
- This product must be used in combination with the optional port for SEA&SEA digital SLR camera housings. This product cannot be used alone.
- This product has been designed and manufactured for use at a water depth within 100m / 330ft. Please note that diving to a depth in excess of 100m / 330ft may cause damage to the product or may lead to water leakage.
- Unauthorized disassembling and/or modification could result in malfunction or flooding, and void product warranty. Take the product to a SEA&SEA authorized service center for repair or inspection.
- Should you notice smoke or an unusual smell coming from the product, turn it off and remove the batteries immediately, taking care to avoid burns. Continued operation could result in injury. After removing the battery, take the product to a SEA&SEA authorized service center for inspection.
- Discontinue use and turn the product off immediately should you notice flooding or leakage.
- When the product is flooding, interior pressure may build up. Please be careful when opening the product as water may spurt out or the cap may open explosively and cause injuries.
- The product has been constructed with an airtight seal. When packing the product for airplane travel, do not seal-up the product to alleviate pressure build up due to atmospheric changes.
- Do not open the product in a wet or sandy environment. Protect the interior from moisture and debris in order to prevent malfunction or flooding.
- Avoid strong shocks/impacts or excess stress to prevent malfunction, damage or breakdown. Make sure that the product has been securely mounted to other products in order to prevent injury, fall or missing.

- Do not rest heavy weight on the product. It might deform the outer casing, damage internal parts, make the waterproofing fail, or result in fire or electric shock.
- Please note that some marks may be left on the camera scraping against the dials or gears of the housing.
- Handle the product carefully so as not to scratch the front port, the lens, the flash window or the finder.
- Always dry the front port, the lens, the flash window or the finder using a soft cloth to prevent stain or salt residue from marring the glass surface.
- Rinse the product with fresh water, after underwater use. Ensure that the product is waterproofed before rinsing. Refer to [Maintenance and Storage] (P.E-24) for details.
- Never use chemicals, cosmetics, any petroleum solvents such as paint thinner, or neutral detergent on the product. They may deform and damage the product.
- Do not leave the product in places with hot temperatures such as inside of a car or in a car trunk in summer. The heat may deform plastic parts of the product, damaging internal parts and resulting in potential fire or electric shock. If the product is sealed tight in hot conditions, heated air expanding inside the product may deform the casing and ruin the waterproofing.
- Do not store the product in wet or high humidity place, to avoid mold, rust, corrosion or malfunction.
- Do not store the product with naphthalene or camphor mothballs, or in locations such as a laboratory where chemicals are used. This environment can cause mold, rust, corrosion or malfunction.
- SEA&SEA SUNPAK Co., Ltd. assumes no liability for compensation of loss of captured images or expenses caused by loss of images, even if you are unable to shoot due to a product defect or malfunction.
- SEA&SEA SUNPAK Co., Ltd. will not be responsible for the replacement or compensation for cameras, lenses or those accessories damaged due to your invalid operation.
- SEA&SEA SUNPAK Co., Ltd. assumes no liability for errors or discrepancies in this manual.
- Carefully observe the O-ring maintenance manual for the handling of O-rings before use.
- The silicon grease included in the product package is inedible.



## Precautions on Handling the O-ring

This product is kept watertight by the O-ring. To keep the O-ring functioning properly, please observe the following. Improper handling of the O-ring could cause flooding.

### CAUTION

- SEA&SEA products use blue O-rings. These O-rings are impregnated with silicone oil through a special process. The lubricating effect of the O-ring lasts as long as the silicone oil is gradually seeping out from within.
- For the maintenance of these blue O-rings, make sure to use genuine SEA&SEA silicone grease (O-ring grease for use with the blue O-rings that comes in tubes with blue lettering and blue caps). If you use silicone grease from other companies or SEA&SEA's own silicone grease that comes in tubes with black lettering and black caps, the grease you apply will be sucked into the blue O-rings due to their special characteristics, which will result in insufficient grease. If this happens even once, the O-ring will not revert to its normal state and must be replaced.
- If the grease is insufficient, the O-ring will not slide, and it will become harder to open and close the waterproof parts. Because of this, it could become impossible to open or close the housing or it could cause flooding, so please refrain from using the housing with insufficient grease.

### Are there any scratches or cracks in the O-ring?

Check the O-ring to make sure there are no scratches or cracks. If there are, replace the O-ring with a new one immediately. When handling the O-ring, do not use pointed metal objects, which could damage the O-ring. Use of the included O-ring remover is recommended.

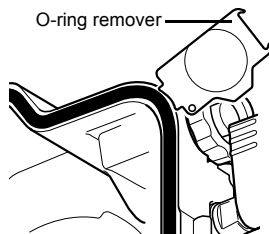

### Be careful about dust, sand, and hair

Check the O-ring to make sure that there is no dust, sand, or hair on the O-ring, in the O-ring's grooves, or on the O-ring's contact surfaces. If any of these things are attached, remove them completely. If used as is, these things could cause flooding.

### Coat with silicone grease

Silicone grease protects the O-ring from chafing. After checking the O-ring to make sure that there are no scratches, dust, or debris, apply a light coating of silicone grease to the entire O-ring with your finger. Applying too much grease will make it easier for dust and debris to adhere to the O-ring, and could cause flooding.



### Do not twist the O-ring

When fitting the O-ring into the O-ring groove, insert it straight into the groove; do not bend or twist it.

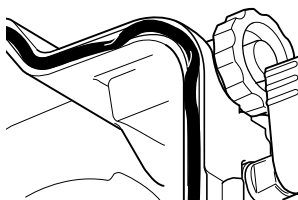

### Remove the O-ring for inspection before each use

In principle, the O-ring should be removed before each use so that the O-ring, O-ring groove, and O-ring contact surfaces can be checked. This is because you cannot find any sand or debris that may have gotten into the O-ring groove if the O-ring is not removed. For routine maintenance prior to each use, it is advisable to make sure to remove the O-ring.

### Be careful about how you store O-rings

When storing spare O-rings or O-rings that you have removed from the housing, keep them in a cool place out of direct sunlight. Also, when storing O-rings, do not place heavy objects on them or twist them.

### O-rings last for one year

Although it depends on how well they are maintained, how often they are used, and how they are stored, O-rings generally last for one year. It is advisable to inspect them before use, and replace them early.

# Identification of Parts

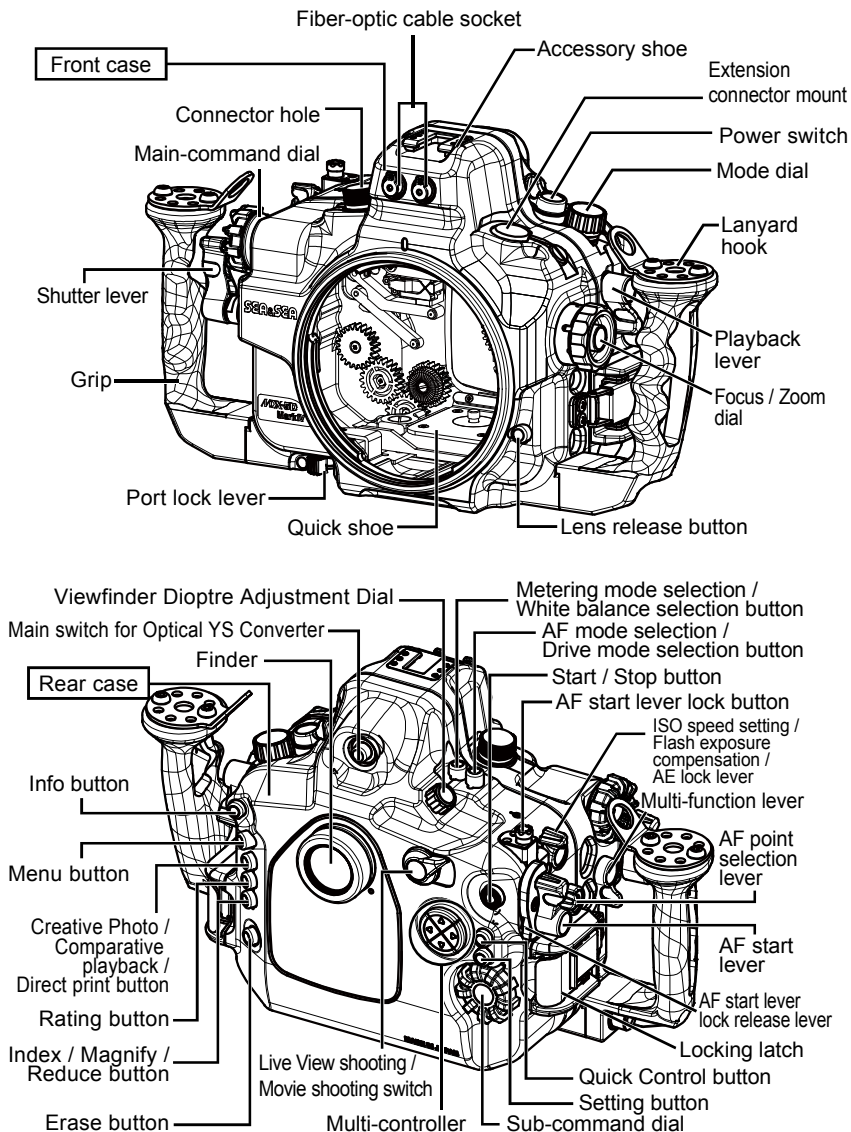

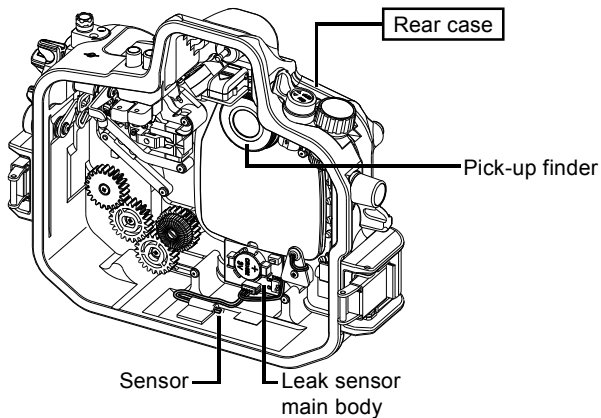
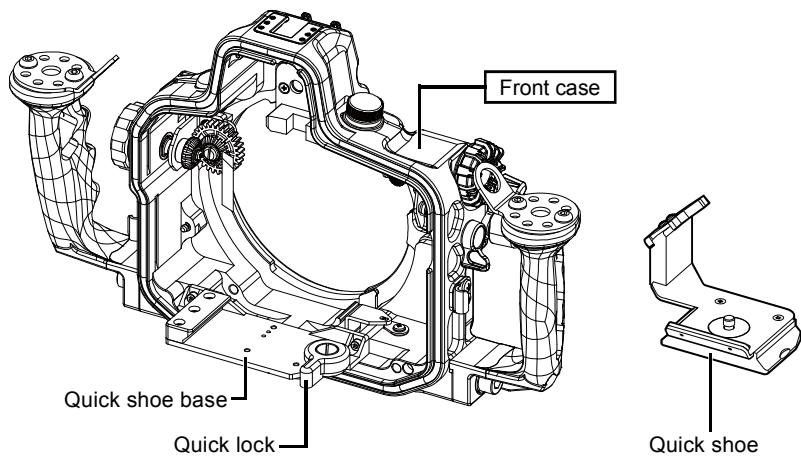

# Preparation for Setting Up

This product must be used in combination with the optional equipment (digital camera, port, strobe, accessories etc.) for underwater photography. In order to set up the equipment, prepare each item correctly.

## Prepare the housing and port

### Maintaining the O-ring

This product is kept watertight by the O-ring. To keep the O-ring functioning properly, please observe the following before setting up.

- Make sure to remove the O-ring when maintaining.
- For detailed O-ring maintenance methods, please see the O-ring maintenance manual.

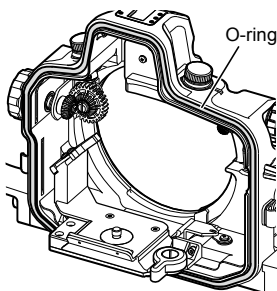

### **⚠ CAUTION**

- Make sure to fit/install the O-ring into the groove properly after maintenance.

## Prepare the digital camera

This product is exclusively designed for use with Canon 5D Mark III / IV digital camera. Other cameras are not compatible with this product.

- Make sure that there is sufficient battery power remaining and the image storage medium has enough room for the number of pictures.
- Remove the eyecup from the camera.
- Remove the strap or the LCD monitor cover from the camera, if any of these accessories are attached.
- If the lens has a focus mode switch, set it properly.
- Make sure the camera is operating correctly, referring to the camera's instruction manual for details.

## Prepare the connecting accessories

When using external strobes, lights or other accessories in combination with this product, prepare the equipment before setting up.

- If the accessories are kept watertight by O-rings, make sure the O-rings are properly maintained.
- If the accessories are powered by batteries, make sure that there is sufficient battery power remaining.
- Make sure the equipment is operating correctly, referring to the instruction manual provided with the equipment.

# Opening and Closing the Housing

Opening and closing the housing is done with the locking latches. Here we will explain how to open and close the locking latches.

## Opening the locking latches

- 1 With the surface of the rear case facing up, press and hold the right and left locks (1) and remove the locking latches from the hooks (2)

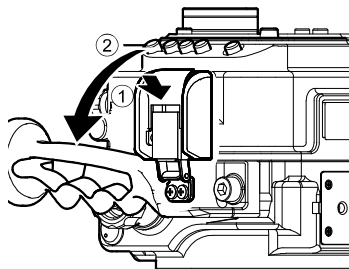

### CAUTION

- When removing the locking latches, be sure to use the tips of your fingers, not your fingernails.
- If you lock the locking latch after it is removed from the hook, it is easier to remove the rear case.

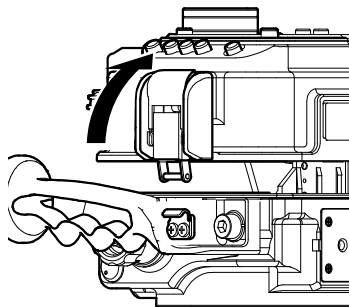

## Closing the locking latches

- 1 Align the front case with the rear case and press them together
- 2 First, put the right and left locking latches on the hooks (1), and close the locking latches simultaneously (2)

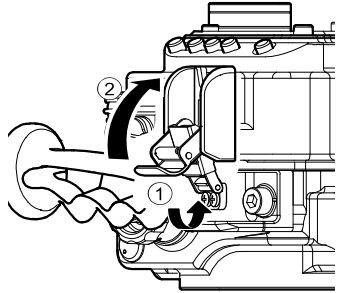

### CAUTION

- Before aligning the rear case and front case, make sure there are no specks of dust, scratches, or deformities on the O-ring and the O-ring contact surfaces.
- Check to make sure that the locking latches are securely locked.

# Attaching and Detaching the Port

In order to use this product underwater, the optional port for the camera lens must be attached to this product.

## CAUTION

- Only the optional ports designed for SEA&SEA digital SLR camera housings can be attached to this product.
- Ports have different depth rating. Check the depth rating for each before use.
- This product is delivered with a housing body cap attached to the port mount. Make sure to remove the housing body cap when attaching the port.
- The housing body cap has no watertight capability.
- When attaching the port to the housing, always refer to the instruction manual provided.

**1** Rotate the port lock lever on the bottom of the front case toward  until you hear the sound of it clicking into the place

**2** Align the positioning mark on the front case with the OPEN mark on the port, insert the port into the front case, and then rotate the port in a clockwise direction until it stops

## CAUTION

Before attaching the port, make sure there are no specks of dust, scratches, or deformities on the O-ring and the O-ring contact surfaces.

**3** Make sure that the positioning mark on the front case and the LOCK mark on the port are aligned

**4** Rotate the port lock lever toward  until you hear the sound of it clicking into place

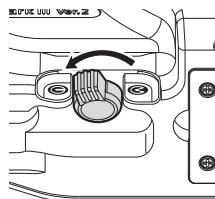
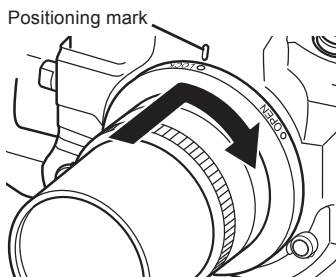
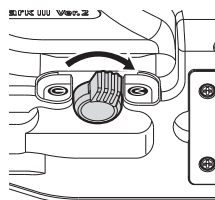



## Detaching the port

- 1 Set the port lock to the  position
- 2 Hold the front case firmly and rotate the port in a counterclockwise direction

### CAUTION

- Do not attempt to remove the port with the port lock lever in the  position. Doing so could damage the quick shoe base.
- If using NX-90PRO ports (with 4-digit part numbers and black bayonets) with this model, it is necessary to modify the port's bayonet. NX-90PRO ports with 5-digit part numbers and gray bayonets can be used as is. For details, please contact SEA&SEA or a SEA&SEA authorized dealer.

# Mounting the Camera in the Housing

## ⚠ CAUTION

- Make sure to remove the eyecup from the camera. If used with the eyecup in place, it could cause flooding.
- Remove the strap or the LCD monitor cover from the camera, if any of these accessories are attached.

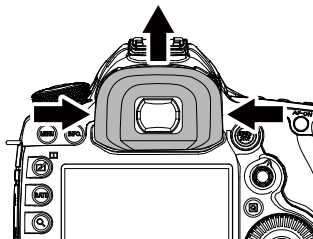

- 1 Rotate the quick lock in the OPEN direction (①), and then remove the quick shoe from the front case (②)

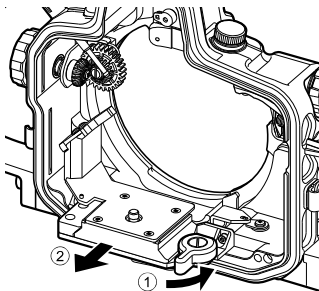

- 2 Using the included attachment tool, fix the quick shoe to the camera's tripod socket

- 3 Attach the lens to the camera, and then set the focus mode (AF or MF)

- 4 Make sure the quick lock is in the OPEN position

- 5 Align the quick shoe with the quick shoe base, and slide the camera fully forward into the front case

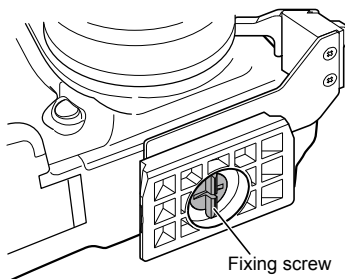

Fixing screw

Pull the focus/zoom dial outwards.

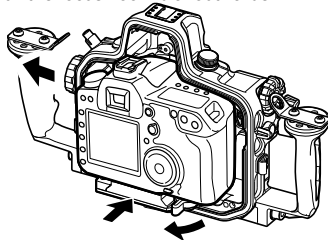

## ⚠ CAUTION

- To prevent focus/zoom control inside front case from obstructing the lens gear, slide the camera into place as you pull the focus/zoom dial outward.

**6** Align the quick lock with the **LOCK** position to fix the camera in place

**7** Align the front case with the rear case and press them together

**8** Close the locking latches

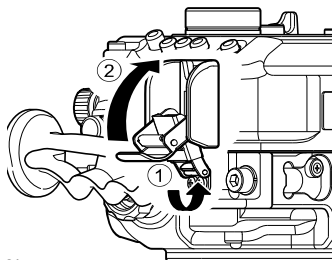

➡ See:

“Opening and Closing the Housing” (P.E-10)

- Make sure that the O-ring is properly fitted in the O-ring groove before setting of the rear case.

### **⚠ CAUTION**

- After the camera is mounted in the housing, make sure to check that all of the housing's control parts work properly and the camera functions correctly.

### **When using the provided light shielding plate**

➡ See:

“Attaching the Optional Accessories” (P.E-24)

### **Removing the camera from the housing**

**1** Open the locking latches

**2** Remove the rear case

**3** Set the quick lock to the **OPEN** position

**4** Slide the camera toward you as you remove the front case

### **⚠ CAUTION**

- If you find the fix screws are too tight, use a coin or similar object to loosen the screws.

## Using external strobe(s)

When using external strobe(s) with this housing, ensure to use the appropriate sync cables and converter, depending on your needs. Options: Optical YS Converter/C, 5pin Sync Cable(s), Fiber-Optic Cable II.

➔See:

"Attaching the Optional Accessories" (Page E-20)

<Attaching example>

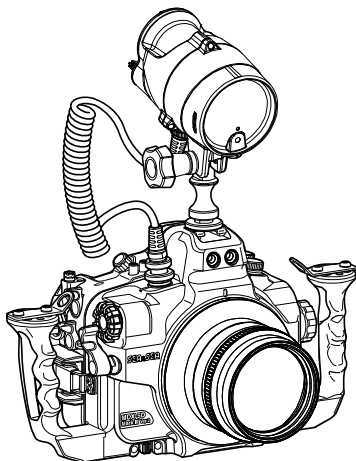

# External Controls

## Power switch

By rotating the knob as shown, you can turn the power ON/OFF and operate the illumination switch.

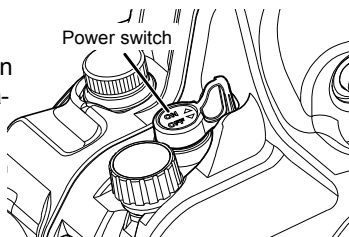

## Focus / Zoom dial

### **When shooting with a focus / zoom gear:**

Pull the focus / zoom dial out and rotate it so that the convex part of the dial is set in the deep groove on the spacer.

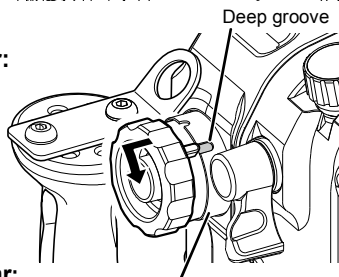

### **When shooting without a focus / Zoom gear:**

Pull the focus / zoom dial out and rotate it so that the convex part of the dial is set in the shallow groove on the spacer.

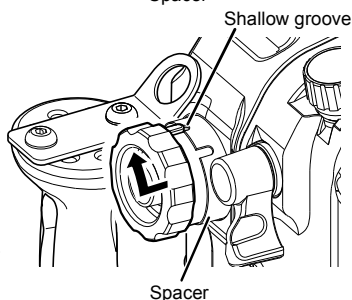

## **⚠ CAUTION**

- The focus / zoom dial cannot be used if there is no gear mounted on the lens.
- When using a zoom gear, you cannot shoot with manual focus.
- If you will be shooting autofocus shots with the focus gear mounted on the lens, make sure to use the shallow groove. If you set it to the deep groove, it could damage the lens.

## Live View shooting / Movie shooting switch

Push the lever to operate them.

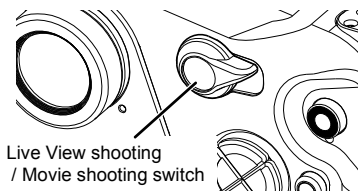

## Shutter lever

Push the lever to operate them.

The strength of the spring for the shutter lever can be changed by adjusting the position of the spring inside the housing.

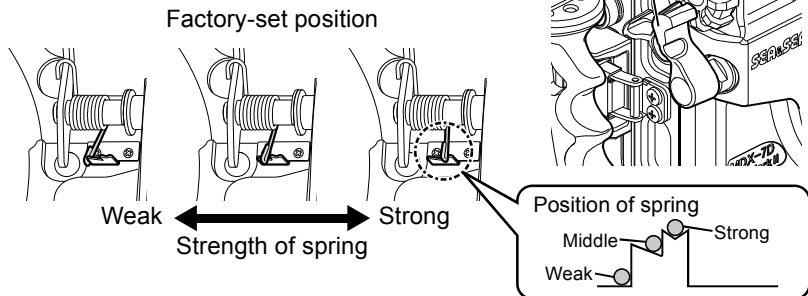

### <Adjusting shutter sensitivity>

The shutter sensitivity can be adjusted in two steps by changing the location of the Adjuster Plate shown in the diagram.

#### Factory-set position

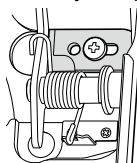

Longer shutter release  
/Less sensitive

#### Sensitivity Adjuster Plate

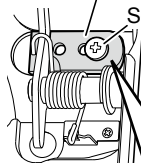

Shorter shutter release  
/More sensitive

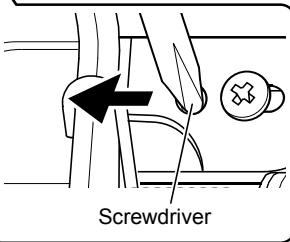
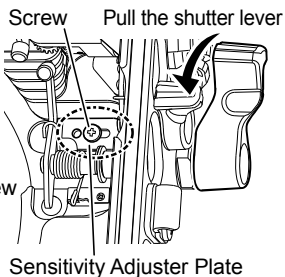

- When shipped from the factory, the housing is set to the long shutter release.

Loosen the screw.

As you press the shutter lever, set the Adjuster Plate as shown with screwdriver.

Tighten the screw.

## ISO speed setting / Flash exposure compensation / AE lock lever, Multi-function lever, AF point selection lever, AF start lever, AF start lever lock button, AF start lever lock release lever

Push the lever to operate them.

### <Locking the AF Start Lever>

Press and turn the AF Start Lever Lock button so it clicks into the depressed position. ①

\* The AF Start Lever can be locked whilst the above button stays depressed.

Push the AF Start Lever forward (with the AF Start Lever Lock button depressed) to lock it into the forward position. ②

The locked AF Start Lever can be released by pushing the AF Start Lever-Lock Release Lever forward. ③

To return the AF Start Lever Lock button to its original position, turn the button .

- The AF Start Lever is not locked when shipped from factory.

ISO speed setting / Flash exposure compensation / AE lock lever

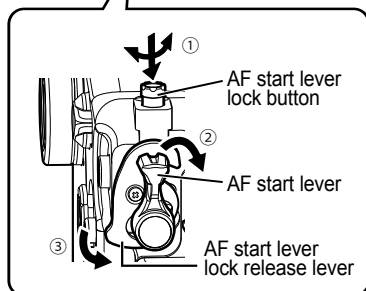
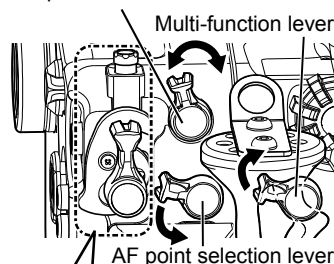

## Viewfinder Dioptre Adjustment Dial

Turn the dial forwards or backwards to that subject look sharp in the viewfinder.

Viewfinder Dioptre Adjustment Dial

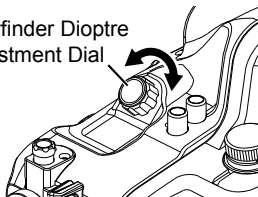

## Other controls

Other control parts on the housing correspond to the operation parts of the digital camera. Refer to the camera's instruction manual for details of each function.

### **CAUTION**

- After mounting the camera in the housing, make sure to check that all of the housing's control parts work properly and the camera functions correctly before underwater use.

### Leak sensor

The leak sensor lights up in red when it detects leakage underwater. If it lights up, surface without delay while ensuring your safety and once out of water remove the camera from the housing.

#### **⚠ DANGER**

- Unauthorized disassembling and/or modification could result in malfunction or flooding, and void product warranty. Take the product to a SEA&SEA authorized service center for repair or inspection.
- Never expose the battery to flame or fire, or to excessive heat.
- Never attempt to disassemble, alter or directly solder the battery.
- There are no user-serviceable parts. Tampering with battery may expose you to dangerous voltage, battery acid, or electrical shock.
- Never short-circuit the terminals of a battery, as it could result in battery leakage, heat generation, fire, or explosion. Avoid contact with all metal objects during transporting and storage.
- Move leaking batteries away from fire or open flames immediately. The leaked fluid and its vapor are combustible.
- If the battery leakage contacts your skin or clothing, flush the affected area repeatedly with clean water. It may irritate your skin. Should it get into your eyes, immediately rinse them with plenty of water, avoid rubbing and seek medical advice.
- Never attempt to insert the battery upside down or backward, as it could result in battery leakage or explosion. Always confirm the direction of plus and minus before installation.
- Never connect a battery directly to a plug outlet or car cigarette lighter.

#### **⚠ WARNING**

- Use only batteries approved for use in this product. Do not mix old and new batteries or batteries of different types.
- Remove batteries before transport or storage, or when you are not going to use the product for an extended period of time, to prevent unexpected activation.

- Keep dry. The battery is not waterproof, and may malfunction if immersed in water or exposed to high levels of humidity. Rusting of the internal mechanism can cause irreparable damage.
- Do not remove and/or damage the case of a battery. It may cause battery leakage, overheating or explosion.
- Never use batteries should you notice any changes such as leakage, discoloration or deformation. When you notice the situation as abnormal, discontinue use immediately and take the product to a SEA&SEA authorized service center for inspection.
- Keep out of reach of children to prevent accidental ingestion. If swallowed, seek medical advice immediately.
- Do not leave or use batteries in an extreme hot environment. This may cause battery leakage, overheating or battery performance deterioration.

#### **⚠ CAUTION**

- Keep away from strong magnetic fields. Do not use or store this product in the vicinity of equipment that generates strong electro-magnetic radiation or magnetic fields. Strong static charges or the magnetic fields could cause malfunction, or affect the product's internal circuitry.
- Avoid strong shocks/impacts or excess stress to batteries.
- Dirt on the battery terminals can prevent the product from functioning. Should the battery terminals become dirty, wipe them with a clean, dry cloth before use.
- Turn the equipment off after use. Remove batteries from the equipment when not in use. Store in dry area with temperatures ranging from 0 to 30°C (32 to 86°F).
- If LED lamp turn red due to malfunction, turn switch to OFF position and return back again to ON to resume normal operation.

## Using the Leak Sensor

### Set the battery

When inserting or replacing the battery, wipe off moisture on the leak sensor thoroughly and make sure that your fingers are dry. Take extra care for water droplets from your hair and wet suit. Otherwise, an electric shock, mold growth on the product, or malfunctioning may occur.

#### Before use

- 1 Set the power switch to ON.

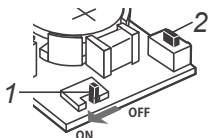

- 2 Press the test light button to confirm that it lights up.
  - The LED lamp lights as long as the test light button is pressed. If it does not light up, replace the battery with a new one.

#### After use

- 1 Set the power switch to OFF.

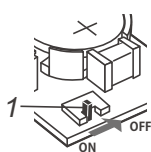

- LED lamp will only light up when the sensor is wet.
- 2 If the forked tip of the sensor section is wet, wipe it with dry cloth.

- If it is not wiped off sufficiently, the LED lamp lights up when the power is switched on.
- When the leak sensor is not to be used for long time, store it with the battery removed.
- Make sure that the ends of the forked tip of the sensor section are not in contact with each other.

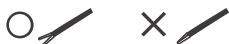

### Maintenance and Storage

- If you will not use the product for an extended period of time, store it away from high temperatures, high humidity, direct sunlight, or extreme cold.
- Do not store the product with naphthalene or camphor mothballs, or in locations such as a laboratory where chemicals are used. This environment can cause mold, rust, corrosion or malfunction.
- Always remove batteries from the product after use.



# Attaching the Optional Accessories

This product accepts SEA&SEA optional accessories. By using this product in combination with those accessories, you will be able to try various shooting techniques.

## **!** CAUTION

- Lenses, strobes and other accessories have different depth rating. Check the depth rating for each before use.
- Read the instruction manual for each accessory before use.

## Optional Sync Cord 2-pin Connector

Connect the cord of the synchro connector to the camera as illustrated below.

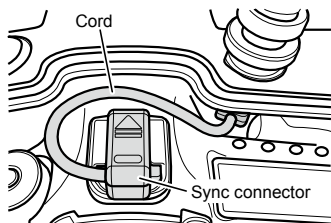

## MDX-5D Mark IV dedicated housing built-in YS converter

A built-in converter can be attached to this product as an option. When the Optical YS converter/C is used, remove the 2-pin connector.

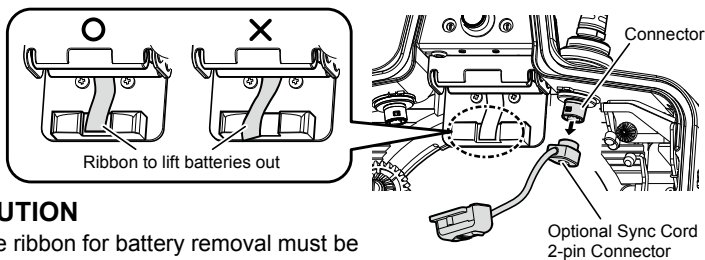

## **!** CAUTION

- The ribbon for battery removal must be located properly as shown.

For details on how to purchase it, please inquire at our sales department or customer support service.

### Finder

This product comes equipped with a 0.5x pick-up finder. The finder can be replaced with an optional finder so you can change the finder magnification to match your shooting conditions.

#### Replacing the finder Unit

The optional VF45 1.2x (46111) or VF120 1.2x (46112) enhances magnification by 1.2x and enables subtle framing and focusing of subjects.

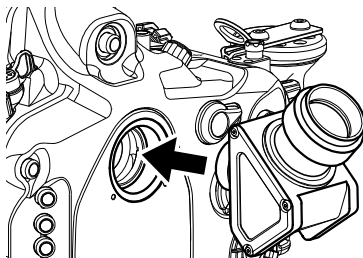

#### **⚠ CAUTION**

- When replacing the finder unit, always refer to the instruction manual provided.

#### Replacing the pick-up finder

**1** Rotate the finder unit mounted on the rear case in a counterclockwise direction to remove it

- The screw areas are coated in grease, so be careful not to touch them.

**2** Rotate the replacement finder unit in a clockwise direction to attach it

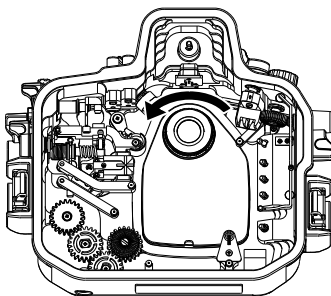

#### **⚠ CAUTION**

- Before attaching the finder, check to make sure that there is no dust, dirt, or debris inside it.
- When replacing the finder, do not touch the surface of the finder lens.
- When replacing the pick-up finder, always refer to the instruction manual provided.

## Arm

### For Sea Arm VII / 8 system

The Sea Arm VII / 8 system can be attached by mounting the optional Bracket Shoe (20100) or SA8 Fixed Ball Base (22119) on the hand grips.

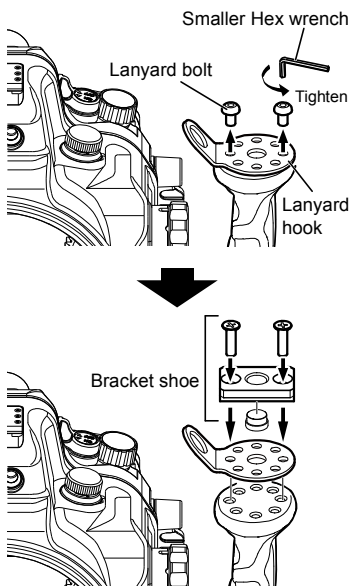

### ⚠ CAUTION

- Use the smaller hex wrench (3mm) provided when removing the lanyard bolts.

## Sacrificial Zinc Anode

This product is equipped with two sacrificial zinc diodes to avoid electrolysis damage. These are expendable parts so when they wear out (become smaller), replace with new ones (#46116).

### ⚠ CAUTION

- Life of sacrificial zinc anodes depends on usage and conditions. Early replacement of sacrificial zinc anodes is recommended.

## Accessory shoe

Strobes / lights can be mounted to the accessory shoe by using optional Mini Shoe Arm (29511) or Hot Shoe Arm (29501) or SA8 Ball Base for Accessory Shoe (22120).

<Example>

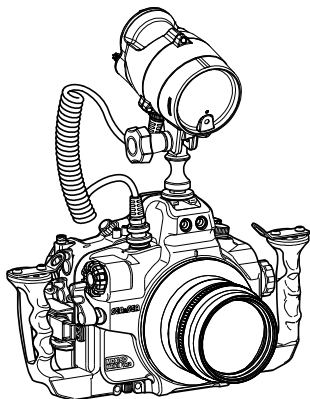
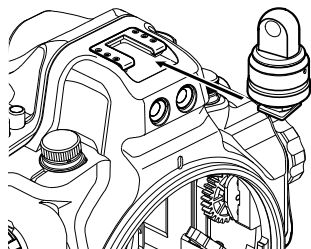

### CAUTION

- The max. weight of an accessory that can be mounted to the accessory shoe is approx. 1050g / 26.3oz .
- Remove the accessories from the accessory shoe when carrying the housing out of water.
- When attaching the accessories to the accessory shoe, always refer to the instruction manual provided.

# Maintenance and Storage

## CAUTION

- Never use chemicals, cosmetics, any petroleum solvents such as paint thinner, or neutral detergent on the product. They may deform and damage the product.
- After each use in salt water, make sure it's watertight, then soak it sufficiently in fresh water.
- Insufficient soaking causes damage by salt to the product. Salty residue may be left on the product where it will crystallize as it evaporates. Crystallized salt is hard to dissolve and difficult to be removed once formed, and it will result in water leakage.
- After rinsing, dry the product well with a soft dry cloth, then let the product dry in the shade, out of direct sunlight.
- Do not dry the product by heating (using a hair dryer, for example). Heating can deform and damage the product.
- If you will not use the product for an extended period of time, store it away from high temperatures, high humidity, direct sunlight, or extreme cold.
- Do not store the product with naphthalene or camphor mothballs, or in locations such as a laboratory where chemicals are used. This environment can cause mold, rust, corrosion or malfunction.
- Always remove the camera from the housing after use. Thoroughly wipe off water before opening the housing and avoid any water drops inside the housing.
- After using the product, maintain the O-rings before storing. Examine the O-rings before and after each dive. We recommend early exchange of the O-rings, at least once a year.
- Every two years we recommend a complete overhaul of O-rings regardless of the frequency in use, for the best performance of the product.

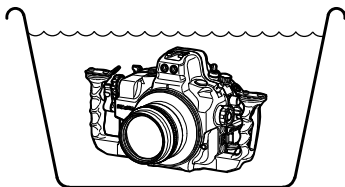

# Specifications

<b>Compatible camera</b>	Canon EOS 5D Mark III / EOS 5D Mark IV
<b>Controls</b>	Power switch, Mode dial, Focus / Zoom dial, Lens release button, Port lock lever, Shutter lever, Main-command dial, Live View shooting / Movie shooting switch, Metering mode selection / White balance selection button, AF mode selection / Drive mode selection button, Start / Stop button, Viewfinder Dioptre Adjustment Dial, ISO speed setting / Flash exposure compensation / AE lock lever, Multi-function lever, AF point selection lever, AF start lever, AF start lever lock button, AF start lever lock release lever, Quick Control button, Setting button, Sub-command dial, Multi-controller, Info button, Erase button, Index / Magnify / Reduce button, Rating button, Creative Photo / Comparative playback / Direct print button, Menu button, Playback lever
<b>Construction</b>	Body: Corrosion-resistant aluminum alloy Grip: Corrosion-resistant die-cast aluminum
<b>Depth rating</b>	100 m (330 feet)
<b>Dimensions</b>	Approx. 341 (W) × 194 (H) × 146.5 (D) mm (13.42 × 7.63 × 5.76 inches)
<b>Weight</b>	Approx. 3000g (6.61 lbs.) (housing only)
<b>Accessories</b>	<ul style="list-style-type: none"><li>•Silicone grease</li><li>•O-ring remover</li><li>•Hex wrench (6mm / for grip dismounting)</li><li>•Hex wrench (3mm / for Lanyard bolt)</li><li>•O-ring maintenance manual</li><li>•Instruction manual (this manual)</li></ul> <b>Attached accessories to the product :</b> <ul style="list-style-type: none"><li>•Housing body cap</li></ul>

\* The specifications and appearance are subject to change without notice.

# SEA&SEA

---

## シーアンドシー・サンパック株式会社

〒145-0062 東京都大田区北千束1-4-6  
TEL.03-5701-5533

### カスタマーサービスセンター

TEL.03-6421-1566  
<http://www.seaandsea.co.jp>

## SEA&SEA SUNPAK Co., Ltd.

1-4-6, Kitasenzoku, Ohta-ku,  
Tokyo, Japan 145-0062  
TEL. +81-3-5701-5533

### World Customer Service Center

TEL. +81-3-6421-1566  
<http://www.seaandsea.jp>

1615-Z-01A

(2016年10月現在 / Current as of Oct.2016)