

SEA&SEA

06138

**UNDERWATER DIGITAL
CAMERA HOUSING**

DX-2G

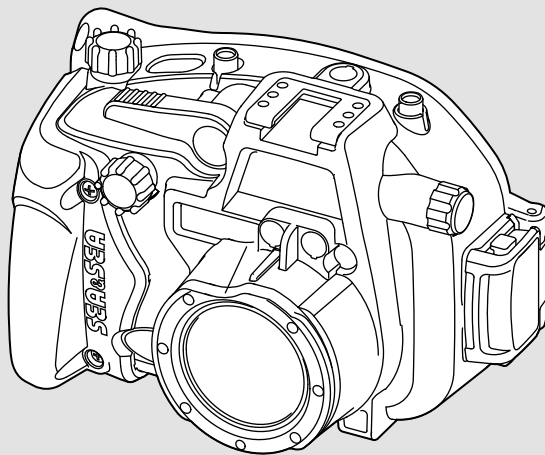

**取扱説明書
Instruction Manual**

日本語

English

Introduction

Thank you for purchasing SEA&SEA products.

Please read this instruction manual carefully prior to using your underwater housing. Only with a thorough understanding of this manual's content will you be able to use the housing correctly. After reading the manual, please be sure to keep it in a place where you can easily come back to it at any time.

Note:

Pressure-resistance inspection sticker



Products bearing this sticker are those that have passed SEA&SEA's criteria-based inspection for pressure resistance.

Contents

Safety Precautions	E-2
Accessories.....	E-4
Identification of Parts.....	E-5
Opening the Rear Cover.....	E-6
Installing the 2G Camera.....	E-7
Operation	E-8
LCD monitor hood.....	E-9
Hand strap.....	E-9
Built-in flashlight diffuser.....	E-10
Optical fiber adapter.....	E-10
Desiccant pack (Silica Gel).....	E-11
Attaching the Optional Accessories.....	E-12
Attaching accessories to the bayonet.....	E-12
Accessory shoe.....	E-13
Maintenance and Storage.....	E-14
Specifications.....	E-15

Safety Precautions

For safe handling of the product, please read the following precautions carefully before use.

Failure to heed the precautions listed below could result in serious consequences. To prevent injury or damage to yourself and/or others, please observe the precautions as they contain highly important information related to personal and product safety.

 **WARNING** Situations that could result in severe injury or death.

 **CAUTION** Situations that could result in property damage or personal injury.

WARNING

- Keep out of reach of children to prevent accidental ingestion. If swallowed, seek medical advice immediately.

CAUTION

- Carefully observe the instruction manual for the compatible camera for this product before use.
- Unauthorized disassembling and/or modification could result in malfunction or flooding, and void product warranty. Take the product to a SEA&SEA authorized service center for repair or inspection.
- Should you notice smoke or an unusual smell coming from the product, turn it off and remove the batteries immediately, taking care to avoid burns. Continued operation could result in injury. After removing the battery, take the product to a SEA&SEA authorized service center for inspection.
- Discontinue use and turn the product off immediately should you notice flooding or leakage.
- When the product is flooding, interior pressure may build up. Please be careful when opening the product as water may spurt out or the cap may open explosively and cause injuries.
- Do not open the chassis or battery cap in the vicinity of open flames.
- The product has been constructed with an airtight seal. When packing the product for airplane travel, do not seal-up the product to alleviate pressure build up due to atmospheric changes.
- Do not open the product in a wet or sandy environment. Protect the interior from moisture and debris in order to prevent malfunction or flooding.

Safety Precautions

- Avoid strong shocks/impacts or excess stress to prevent malfunction, damage or breakdown. Make sure that the product has been securely mounted to other products in order to prevent injury, fall or missing.
- Do not rest heavy weight on the product. It might deform the outer casing, damage internal parts, make the waterproofing fail, or result in fire or electric shock.
- Please note that some marks may be left on the camera scraping against the dials or gears of the housing.
- Handle the product carefully so as not to scratch the front port, the lens, the flash window or the finder.
- Always dry the front port, the lens, the flash window or the finder using a soft cloth to prevent stain or salt residue from marring the surface.
- Rinse the product with fresh water, after underwater use. Ensure that the product is waterproofed before rinsing. Refer to [Maintenance and Storage] (P.E-14) for details.
- The product has been constructed with an airtight seal. When packing the product for airplane travel, do not seal-up the product to alleviate pressure build up due to atmospheric changes.
- Never use chemicals, cosmetics, any petroleum solvents such as paint thinner, or neutral detergent on the product. They may deform and damage the product.
- Do not leave the product in places with hot temperatures such as inside of a car or in a car trunk in summer. The heat may deform plastic parts of the product, damaging internal parts and resulting in potential fire or electric shock. If the product is sealed tight in hot conditions, heated air expanding inside the product may deform the casing and ruin the waterproofing.
- Do not store the product in wet or high humidity place, to avoid mold, rust, corrosion or malfunction.
- Do not store the product with naphthalene or camphor mothballs, or in locations such as a laboratory where chemicals are used. This environment can cause mold, rust, corrosion or malfunction.
- SEA&SEA SUNPAK Co., Ltd. assumes no liability for compensation of loss of captured images or expenses caused by loss of images, even if you are unable to shoot due to a product defect or malfunction.
- SEA&SEA SUNPAK Co., Ltd. will not be responsible for the replacement or compensation for cameras, lenses or those accessories damaged due to your invalid operation.
- SEA&SEA SUNPAK Co., Ltd. assumes no liability for errors or discrepancies in this manual.
- Carefully observe the O-ring maintenance manual for the handling of O-rings before use.

Accessories

Before using this model, check to make sure that all accessories are present.

DX-2G

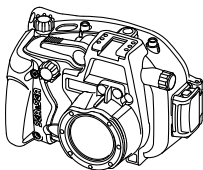

LCD Monitor Hood

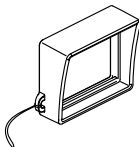

Hand Strap



Silicon Grease



O-ring remover

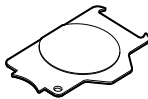

Desiccant Pack
(Silica Gel)



Optical Fiber Adapter

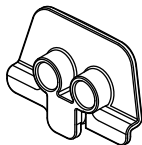

- O-ring Maintenance Manual
- DX-2G Instruction Manual (this manual)

Identification of Parts

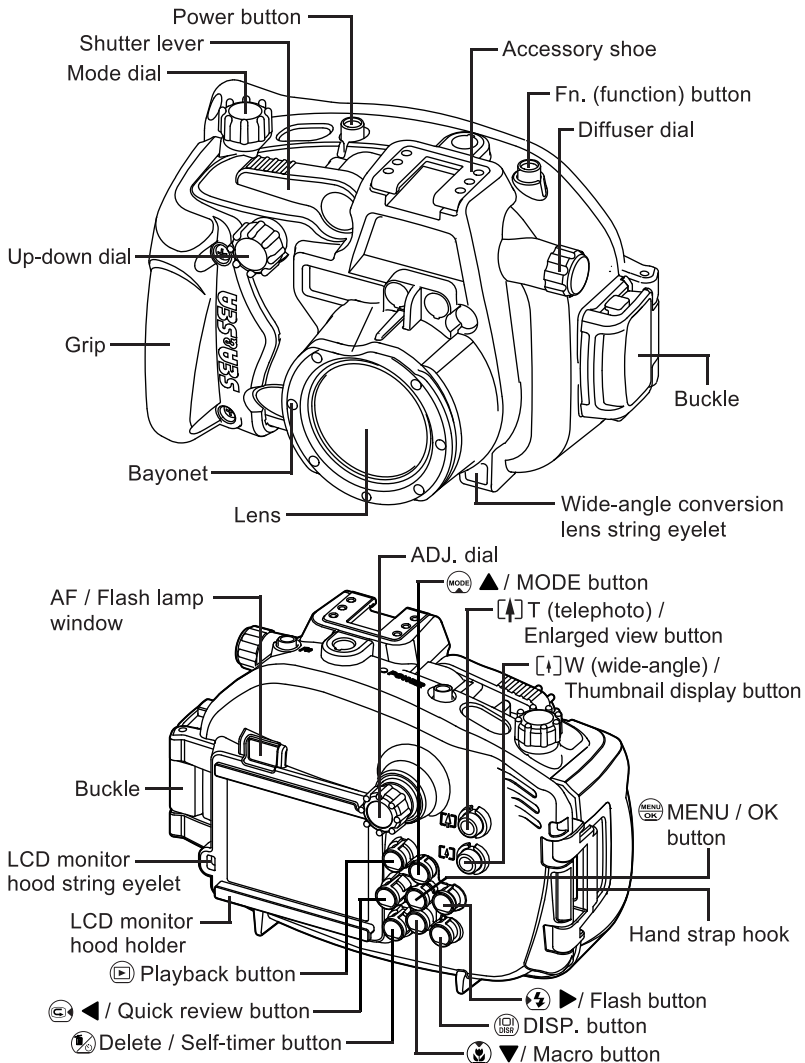

Opening the Rear Cover

- 1 Push the red buckle lock buttons together to unlock, and pull the buckle all the way towards back to lift the rear cover from the front case

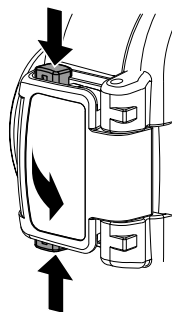

- 2 Pull the rear cover to open

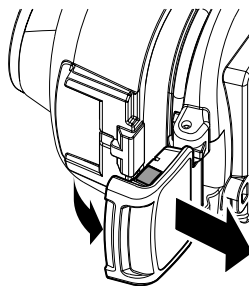

CAUTION

- Before opening the rear cover, make sure that the housing is completely dry and free of salt deposits. If you find any salt deposits, rinse with fresh water and wipe off water completely with a soft cloth.
- Never use the buckle/buckle lock buttons underwater.
- When opening the rear door after use in the water, open it carefully not to let water or sand enter inside the housing.

Installing the 2G Camera

- Before installing the 2G camera, slide the Flash OPEN switch to the outside to raise the flash cover, open the flash, and remove the lens cap from the camera. Turn off the power of the camera before installation.
- This housing is only compatible with the 2G camera.

1 Turn off the power of the 2G camera and place it as shown in Fig.1

2 Make sure that there is no dust or scratches on the O-ring / O-ring contact surface before closing the rear cover. Take the hand strap out, press the rear cover, and then put the buckle over the front case (Fig.2)

3 Push the buckle down until it clicks. Make sure that the red buckle lock buttons on both sides are popped out (Fig.3)

CAUTION

- To avoid flooding by trapping, remove the wrist strap from 2G camera before installation.
- Never install or remove the 2G camera while the camera is ON. The ejected lens may interfere with the housing and damage the camera and lens.
- Make sure that the 2G camera is set parallel to the housing and not excessively slanted.

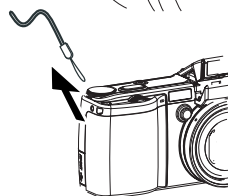
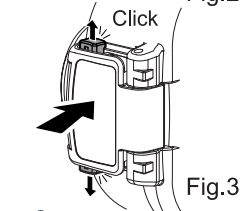
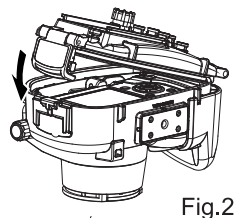
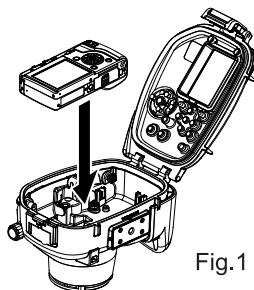
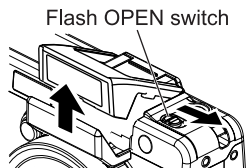

Operation

Power button

Use the power button to turn ON / OFF the 2G camera.

Power button

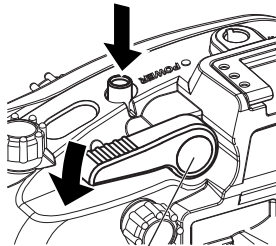

Shutter lever

Shutter lever

Depress the shutter lever to press the shutter button of the 2G camera.

Mode dial

Turning this dial changes the shooting mode. Mode setting status is displayed at the top center of the LCD monitor of the 2G camera.

Mode dial

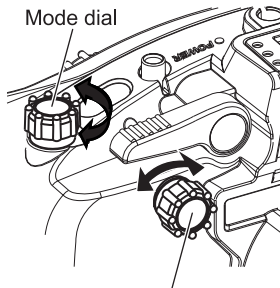

Up-down dial

Up-down dial

Turning this dial rotates the up-down dial on the 2G camera. Use this dial to work with the menu and to change aperture or setting value quickly and easily.

ADJ. dial

ADJ. dial

Pushing and flicking this dial to the right and left operates the ADJ. lever of the 2G camera.

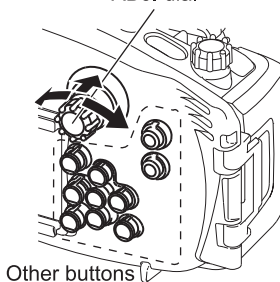

Other buttons

Other buttons

Use buttons to control each function of the 2G camera underwater. Please refer to the instruction manual of the 2G camera for operation of the other buttons.

LCD monitor hood

- 1 Put the LCD monitor hood string through the rear cover eyelet as shown

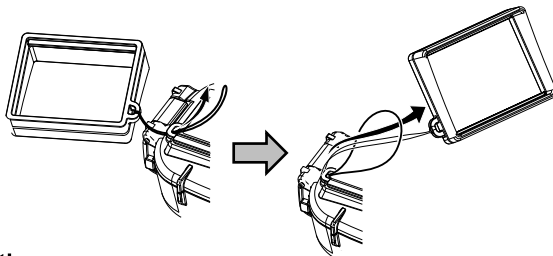

- 2 Mount the LCD monitor hood to the holder

CAUTION

- Please be careful not to get the strap of the LCD monitor hood caught in the rear cover when closing.
- Do not hold the LCD monitor hood to carry the housing. It may come off and the housing may fall down.

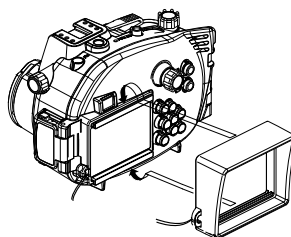

Hand strap

Attaching the hand atrap

Put the hand strap through the hook on the housing, let other end go through between the strap, and pull the strap tight as shown.

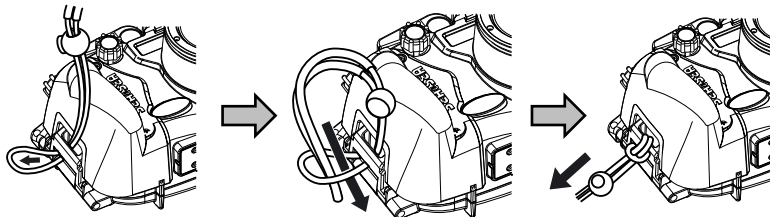

- Do not use the strap when out of water if using optional accessories (such as a wide-angle conversion lens, stay, arm, and strobe / light). The increased weight of the accessories may damage the strap and the strap hook, which may result in equipment damage / loss or personal injury.

Built-in flashlight diffuser

Turning the dial forward sets the built-in flashlight diffuser inside the flash window. The diffuser disperses and softens light from the built-in flash of the 1G camera. It helps prevent backscatter --- that is, it reduces light reflection from particles in the water.

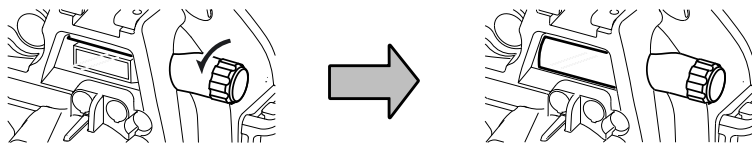

⚠ CAUTION

- The camera's built-in flash cannot illuminate the subject uniformly due to the structure of the housing. Use of an external strobe is recommended.

Optical fiber adapter

When using an optional external strobe with this housing, please use the optical fiber adapter supplied with this housing for proper connection.

Firmly attach the optical fiber adapter to the housing first, and insert the fiber-optic cable into the adapter as far as it will go. If you directly insert the fiber-optic cable into the housing without the adapter, the connected external strobe may operate erratically.

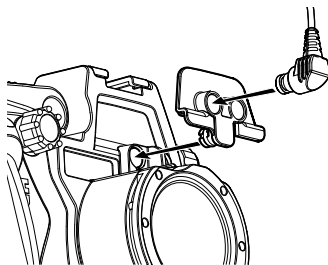

⚠ CAUTION

- External strobes made by companies other than SEA&SEA SUNPAK Co., Ltd. are not guaranteed to operate properly.
- The SEA&SEA YS-110 strobe may malfunction even if the optical fiber adapter is used.

Desiccant pack (Sillica Gel)

A substantial difference between the external (water) and the internal (camera and air) temperatures sometimes result in dewfall on the inside surface of the housing lens. This phenomenon typically happens when the camera becomes hot due to long and consecutive use.

To mitigate the effect of the dew, use the desiccant pack (included in the product package) as follows;

Using the desiccant pack (Sillica Gel)

- 1 Install the 2G camera to the housing
- 2 Place a desiccant pack (Sillica Gel) at the location as shown, then close the rear cover

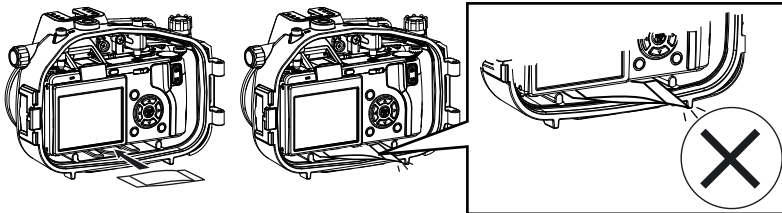

⚠ CAUTION

- Make sure that the edge of the desiccant pack is not covering the O-ring contact surface.
- Make sure that the desiccant pack is not trapped when closing the rear cover.

Attaching the Optional Accessories

This product accepts SEA&SEA optional accessories. By using this product in combination with those accessories, you will be able to try various shooting techniques.

- Lenses, strobes and other accessories have different depth rating. Check the depth rating for each before use.
- Read the instruction manual for each accessory before use.

Attaching accessories to the bayonet

SEA&SEA optional accessories can be attached to the bayonet on this housing. Refer to our website or product catalog for detailed information on compatible accessories.

Example: How to attach the wide-angle conversion lens for DX-1G (#52116)

- 1 **Align the salient on the upper surface of the housing lens and the mark on the lens bayonet, then impose the close-up lens to the housing**
- 2 **Turn the close-up lens clockwise until it clicks**

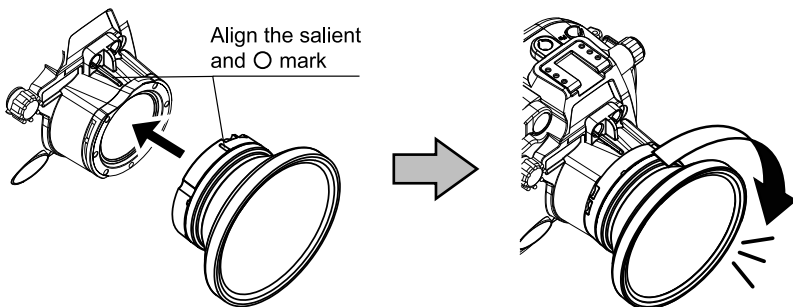

⚠ CAUTION

- When using the lens, loosen or lightly shake the lens while underwater to remove any air trapped between the lens and the housing.

Accessory shoe

SEA&SEA strobes / lights can be mounted to the accessory shoe by using optional Mini Shoe Arm (#29511) or Hot Shoe Arm (#29501).

<Example>

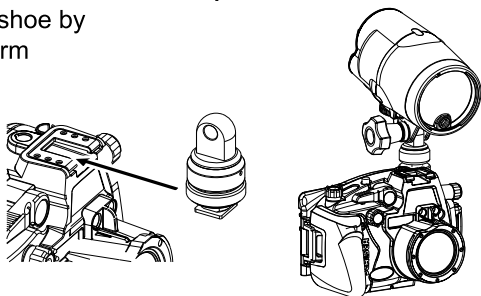

CAUTION

- The max. weight of an accessory that can be mounted to the accessory shoe is approx. 750g / 26.3oz (equivalent to the weight of SEA&SEA YS-110 α strobe).
- Remove the accessories from the accessory shoe when carrying the housing out of water.

Maintenance and Storage

CAUTION

- Never use chemicals, cosmetics, any petroleum solvents such as paint thinner, or neutral detergent on the product. They may deform and damage the product.
- After each use in salt water, make sure it is watertight, then soak it sufficiently in fresh water and rinse with running water.



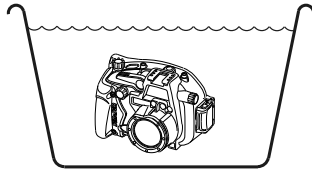





Operate all the buttons, dials or levers underwater, but do not operate the buckle / buckle lock buttons.



- Insufficient soaking causes damage by salt to the product. Salty residue may be left on the product where it will crystallize as it evaporates. Crystallized salt is hard to dissolve and difficult to be removed once formed, and it will result in water leakage.
- After rinsing, dry the product well with a soft dry cloth, then let the product dry in the shade, out of direct sunlight.
- Do not dry the product by heating (using a hair dryer, for example). Heating can deform and damage the product.
- If you will not use the product for an extended period of time, store it away from high temperatures, high humidity, direct sunlight, or extreme cold.
- Do not store the product with naphthalene or camphor mothballs, or in locations such as a laboratory where chemicals are used. This environment can cause mold, rust, corrosion or malfunction.
- Always remove the camera from the housing after use. Thoroughly wipe off water before opening the housing and avoid any water drops inside the housing.
- After using the product, maintain the O-rings before storing. Examine the O-rings before and after each dive. We recommend early exchange of the O-rings, at least once a year.
- Every two years we recommend a complete overhaul of O-rings regardless of the frequency in use, for the best performance of the product.

Specifications

Compatible camera 2G

Controls Power button, Shutter lever, Mode dial, Up-down dial, Diffuser dial, Fn.(Function) button,  Playback button,  ◀ / Quick review button,  Delete / Self-timer button,  ▼ / Macro button,  MENU / OK button,  ▲ / MODE button,  ► / Flash button,  DISP. button, [L] W (wide) / Thumbnail button, [T] T (telephoto) / Enlarge display button, ADJ. dial

Construction Body: Polycarbonate
Grip: ABS resin

Depth rating 55m

Dimensions Apporox.158(W)×109(h)×109(D) mm
(6.3×4.4×4.4 inches)

Weight Apporox. 510g / 17.9oz (housing only) /
Apporox. -110g / -3.9oz (underwater)

Accessories LCD monitor hood, O-ring remover, Desiccant pack (Silica Gel), Hand strap, Silicone grease, Optical fiber adapter, O-ring maintenance manual, Instruction manual

* The specifications and appearance are subject to change without notice.

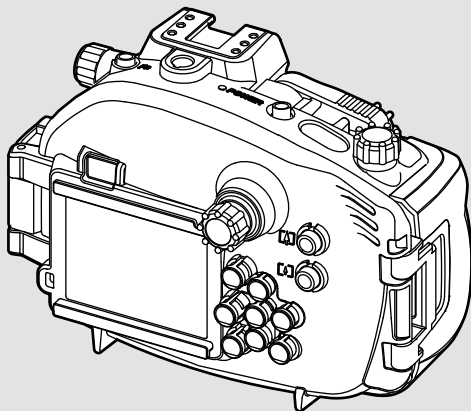

SEA&SEA

シーアンドシー・サンパック株式会社

〒332-0016 埼玉県川口市幸町3-2-20

TEL.048-256-2251

カスタマーサービスセンター

TEL.048-255-8512

<http://www.seaandsea.co.jp>

SEA&SEA SUNPAK Co., Ltd.

3-2-20, Saiwai-cho, Kawaguchi-shi,

Saitama, Japan 332-0016

TEL. +81-48-256-2251

World Customer Service Center

TEL. +81-48-255-8512

<http://www.seaandsea.jp>

0817-Z-01